

GPSMAP® 182/182C

chartplotting receiver

owner's manual



(GPSMAP 182C shown)

© Copyright 2005 Garmin Ltd. or its subsidiaries

Garmin International, Inc.
1200 East 151st Street,
Olathe, Kansas 66062, U.S.A.
Tel. 913/397.8200 or 800/800.1020
Fax 913/397.8282

Garmin (Europe) Ltd.
Unit 5, The Quadrangle,
Abbey Park Industrial Estate,
Romsey, SO51 9DL, U.K.
Tel. 44/0870.8501241
Fax 44/0870.8501251

Garmin Corporation
No. 68, Jangshu 2nd Road, Shijr,
Taipei County, Taiwan
Tel. 886/2.2642.9199
Fax 886/2.2642.9099

All rights reserved. Except as expressly provided herein, no part of this manual may be reproduced, copied, transmitted, disseminated, downloaded or stored in any storage medium, for any purpose without the express prior written consent of Garmin. Garmin hereby grants permission to download a single copy of this manual onto a hard drive or other electronic storage medium to be viewed and to print one copy of this manual or of any revision hereto, provided that such electronic or printed copy of this manual must contain the complete text of this copyright notice and provided further that any unauthorized commercial distribution of this manual or any revision hereto is strictly prohibited.

Information in this document is subject to change without notice. Garmin reserves the right to change or improve its products and to make changes in the content without obligation to notify any person or organization of such changes or improvements. Visit the Garmin Web site (www.garmin.com) for current updates and supplemental information concerning the use and operation of this and other Garmin products.

Garmin[®], GPSMAP[®], AutoLocate[®], TracBack[®], See-Thru[®], MetroGuide[®], BlueChart[®], and MapSource[®] are registered trademarks of Garmin Ltd. or its subsidiaries and may not be used without the express permission of Garmin.

INTRODUCTION

Thank you for choosing the Garmin® GPSMAP® 182/182C. Take a moment now to compare the contents of this package with the packing list on the outside of the box. If any pieces are missing, contact your Garmin dealer immediately.

Before you begin working with the GPSMAP 182/182C, review the installation instructions listed in the Appendix. If you have any question about installing your chartplotter, contact Garmin Product Support or a professional installer.

The GPSMAP 182/182C Quick Reference Guide contains helpful tips on using the unit and performing various navigation tasks. It is a good idea to keep the Quick Reference Guide nearby whenever you are operating your new GPSMAP 182/182C.

About This Manual

To get the most out of your new navigation system, take time to read this manual and learn the operating procedures for your unit in detail. This manual is organized into the following sections.

The **Introduction** section contains the Table of Contents and GPSMAP 182/182C care information.

The **Basic Operation** section provides you with detailed information and step-by-step directions for features such as using the Find Menu, navigating a route, and using waypoints.

The **Main Pages** section provides detailed explanations about each page in the GPSMAP 182/182C and step-by-step directions on using the pages.

The **Main Menu** section provides detailed explanations about the Main Menu and how to use it to configure your unit.

The **Using Sonar** section contains information on optional sonar capabilities.

The **Appendix** contains installation instructions, specifications, optional accessories, and maintenance information. You can also find warranty and FCC information in the Appendix. **Read the Safety Information to learn how to install and use your Garmin GPSMAP 182/182C safely and responsibly.**

An Index is provided at the end of the manual for reference.

Table of Contents

Introduction	i	Receiving DSC Calls.....	23
About This Manual	i	Navigating to a Position Report or Distress Call.....	25
Care Information	iv	Setting up DSC	25
Basic Operation	1	Main Pages	26
Initializing the Receiver	1	Map Page	27
Simulator Mode	3	Using the Map Pointer.....	28
Adjusting the Backlight	4	Selecting Map Zoom Range	29
Interface Keys	5	Map Page Options	30
Entering Data and Selecting Options	6	Pointer Page	33
Using the Map Pointer	7	Numbers Page	34
Creating and Using Waypoints	8	Highway Page	35
ENTER/MARK Key.....	8	Highway Page Options	36
Creating Waypoints Graphically.....	9	Active Route Page	37
Man OverBoard (MOB)	10	Active Route Page Options.....	38
Reviewing and Editing Waypoints	11	Main Menu	39
Navigating to a Destination	12	GPS Tab	40
Using the Nav Key	12	WAAS Capability	41
Selecting a Go To Graphically.....	13	GPS Tab Options	43
TracBack Navigation (Navigating a Track).....	14	Tide Tab	44
Routes	17	Trip Tab	47
Find	19	Celes (Celestial) Tab	47
Additional Information	21	Points Tab	49
DSC	22	Routes Tab	53
Understanding Distress Calls.....	22	Track Tab	59
Understanding Position Reports	23	DSC Tab	62
		Card Tab	62

Time Tab	63	Whiteline	91
Pages Tab	63	Thermoclines	91
Map Tab	64	Appendix	92
General Sub Tab	64	Specifications	92
Source Sub Tab	65	Installing the GPSMAP 182/182C	93
Waypoints Sub Tab	66	Mounting the GPSMAP 182/182C	94
Points Sub Tab	66	Installing the Ferrite Bead Clamp	97
Nav aids Sub Tab	67	Connecting the Power/Data Cable	98
Nav Line Sub Tab	67	Interfacing	99
Track Sub Tab	67	Installing and Removing Data Cards	100
Other Sub Tab	68	Satellite Information	101
Hiway (Highway) Tab	68	What is WAAS?	102
Temp (Temperature) Tab	68	What is Differential GPS (DGPS)?	102
Sonar Tab	69	What is a Maritime Mobile Service Identity (MMSI)?	103
System (System) Tab	69	How are MMSI Assignments Obtained?	103
Units Tab	70	Navigation Terms	104
Comm (Communications) Tab	72	Messages	106
Alarm Tab	76	LORAN TD System	108
Using Sonar	78	Optional Accessories	110
Sonar Page	78	Software License Agreement	111
Using the Adjustment Menu	79	Product Registration	111
Sonar Page Options	83	Limited Warranty	112
Sonar Tab Options	85	FCC Compliance	113
Understanding Sonar	89	Safety Information	114
Understanding the Sonar Display	89	Index	115
Transducer Coverage	90		

Care Information

Cleaning the Unit

The GPSMAP 182/182C is constructed of high quality materials and does not require user maintenance other than cleaning. Clean the unit using a cloth dampened with a mild detergent solution and then wipe dry. Avoid chemical cleaners and solvents that can damage plastic components.

Storing the GPSMAP 182/182C

Do not store the GPSMAP 182/182C where prolonged exposure to temperature extremes can occur (such as in the trunk of a car) as permanent damage can result. User information, such as waypoints and routes are retained in the unit's memory without the need for external power. It is always a good practice to back up important user data by manually recording it or downloading it to a PC (transferring it to MapSource.)

Immersing the Unit in Water

The GPSMAP 182/182C is waterproof to IEC Standard 60529 IPX7. It can withstand immersion in 1 meter of water for 30 minutes. Prolonged submersion can cause damage to the unit. After submersion, be certain to wipe and air dry the unit before reuse.

To resolve problems that cannot be remedied using this manual, contact Garmin Product Support in the U.S.A. at 800/800-1020 or Garmin Europe at 44/0870-8501241.

BASIC OPERATION

Initializing the Receiver

The first time you turn on the GPSMAP 182/182C, the receiver must be given an opportunity to collect satellite data and establish its present location. To ensure proper initialization, the GPSMAP 182/182C is shipped from the factory in AutoLocate mode.

Before you initialize, make sure the GPSMAP 182/182C unit and antenna have been correctly installed on your vessel according to the instructions in the Appendix. Install the antenna in a location with a clear and unobstructed view of the sky.

A full-screen GPS Information Page is displayed after you press **ENTER** to acknowledge the Warning Page. The page goes away after the unit gets a position fix or you press either **ENTER** or **QUIT**. The page can be disabled and enabled on the Main Menu—Pages tab (see page 63).

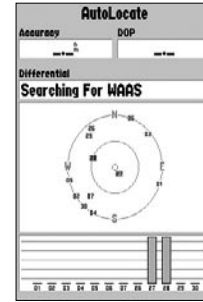

To turn on the GPSMAP 182/182C:

1. Press and hold the **POWER** key until the power tone sounds, and then release the **POWER** key. The Warning Page appears while the unit conducts a self-test.
2. When the self-test is complete, press **ENTER** to agree and acknowledge the warning.

The GPS Information Page appears as the receiver begins acquiring satellites.

To turn off the GPSMAP 182/182C:

1. Press and hold the **POWER** key for approximately 2 seconds, until the screen is blank.
2. When the screen is blank, release the **POWER** key.

To graphically initialize the GPSMAP 182/182C:

1. Press **MENU** twice for the Main Menu. Press up or down on the **ROCKER** until the **GPS** tab is highlighted, and press **MENU** one time.
2. Using the **ROCKER**, highlight **Initialize Position**, and press **ENTER**. The Initialize Position Page appears, prompting you to select your approximate location with the map pointer.
3. Use the **ROCKER** to move the map pointer to your approximate location within 200 miles. If you have difficulty identifying your location, press and release the **IN** key to see the next lower map range.
4. After you determine your approximate location on the map, press **ENTER**.



NOTE: This does not calibrate the unit in any way, but rather helps to speed up the initial satellite acquisition. If the unit displays “Ready 2D or 3D” during this process, it is not necessary to initialize the unit.

The GPSMAP 182/182C now begins searching for the appropriate satellites for your region and should acquire a fix within a few minutes. When viewing the GPS tab on the Main Menu, a signal strength bar for each satellite in view appears on the bottom of the page, with the appropriate satellite number under each bar.



- **No signal strength bars**—the receiver is looking for the satellites indicated.
- **Hollow signal strength bars**—the receiver has found the indicated satellite(s) and is collecting data.
- **Solid signal strength bars**—the receiver has collected the necessary data and the satellite(s) are ready for use.

When the receiver has collected information from at least three satellites, the top of the screen displays either “Ready 2D or 3D”, and the GPSMAP 182/182C is ready for use.

Simulator Mode

Simulator Mode turns the GPS receiver off for use indoors or practice. Any of the functions discussed in the following pages can be performed in Simulator Mode. While in Simulator Mode, a “Running Simulator” message appears after 2 minutes of inactivity. Keep in mind that the GPSMAP 182/182C does not track satellites in Simulator Mode, and this mode should never be used for actual navigation. All the waypoint and route planning completed in Simulator Mode is retained in memory for future use.



NOTE: Do not attempt to navigate using Simulator Mode. When the unit is set to Simulator Mode, the GPS receiver is turned off. Any satellite signal strength bars displayed are only simulations and do not represent the strength of actual satellite signals.

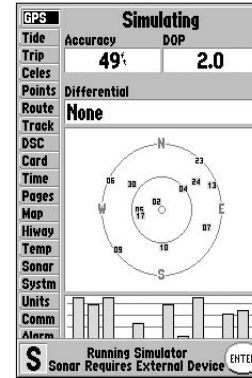

To place the GPSMAP 182/182C in Simulator Mode:

1. Press **MENU** twice to display the Main Menu. Press up or down on the **ROCKER** until the **GPS** tab is highlighted, then press **MENU**.
2. Use the **ROCKER** to highlight **Start Simulator**, and press **ENTER**. Highlight **No** on the retail demonstration window, and press **ENTER**.
3. Press **ENTER** to confirm the **Running Simulator** message that appears at the bottom of the display. **Simulating** appears at the top of each of the Main pages.
4. To turn off the Simulator Mode, press **MENU**, and select **Stop Simulator**.

The Set Position, Track Control, Track and Speed fields only show while in Simulator Mode.

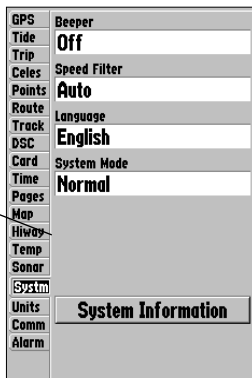

To enter a simulated speed and heading from the Main Menu:

1. Press **MENU** twice to display the Main Menu.
2. Use the **ROCKER** to highlight the **System** tab, press right then down until the field below the word **Speed** is highlighted, and press **ENTER**.
3. Use the **ROCKER** to enter a speed, and press **ENTER**.
4. Use the **ROCKER** to highlight **Track Control**. Press **ENTER**, and select a heading.
5. Press **ENTER** to finish, and **QUIT** until you return to the Map Page.

To adjust the simulated speed and heading from the Pointer or Highway Pages:

1. Press up on the **ROCKER** increase the speed in 10 knot/kph/mph increments. Press down on the **ROCKER** to decrease the speed in the same increments.
2. Press left and right on the **ROCKER** to steer the boat.

Adjusting the Backlight

The GPSMAP 182/182C's screen backlight is controlled with the **POWER** key, and can be adjusted from any page.



To adjust the backlight:

1. Press and release the **POWER** key. The adjustment slider window appears.
2. Press the **POWER** key again to start the user-defined backlight level. To adjust this level, press up or down on the **ROCKER**. If you press **POWER** one more time, the backlight is at the maximum setting.
3. Press **ENTER** or **QUIT** when finished.

Interface Keys

NAV Key

- Press and release at any time to view the Navigation menu.

QUIT Key

- Press and release to cancel data entry or exit a page.

ROCKER Key

- Press up/down or right/left to move through lists, highlight fields, on-screen buttons and icons, enter data, or move the map pointer.

FIND Key

- Press to search for points such as user waypoints, cities, and services.

POWER Key

- Press and hold to turn unit on or off.
- Press and release to adjust backlighting.



IN/OUT Zoom Keys

- From the Map Page, press to zoom in or out.
- From any other page, press to scroll up or down a list.

PAGE Key

- Press to cycle through the Main pages.
- Press to end an operation in progress and return to the main page.

MENU Key

- Press and release to view options for a page.
- Press twice to view the Main Menu.

ENTER/MARK Key

- Press and release to enter highlighted options and data or confirm on-screen messages.
- Press and hold at any time to mark your current location as a waypoint.

MOB Key

- Press and hold for MOB (Man OverBoard).

Entering Data and Selecting Options

You can select and activate options, and enter data to customize the GPSMAP 182/182C to fit your requirements. Use the **ENTER** key and the **ROCKER** to select options, enter names and numbers in data fields, and start your selections.

To select optional feature:

1. With any page displayed, press **MENU** to display the options menu. The options menu displays a list of optional features that are specific for that page. To select an option requires movement of the cursor. This is referred to as highlighting, selecting, or choosing an item.
2. Use the **ROCKER** to move the cursor (highlight) up and down a list or up, down, left, and right on menus.
3. After you highlight the selection, press **ENTER** to start the feature, or press **MENU** to display a sub-menu or list with more feature options. Repeat this process to select an option from the list, or press **QUIT** to return to the previous setting.

Some pages contain on-screen buttons. As shown below, the New Waypoint Page has three function buttons: **Map**, **Delete**, and **OK**. To activate a function, highlight the button, and press **ENTER**.

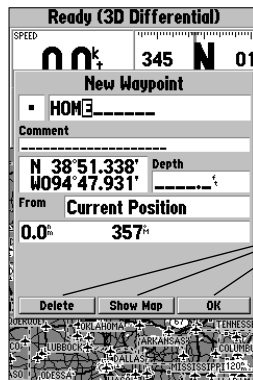

Function Buttons

Using the Map Pointer

Working from the Map Page centers around the use of the pointer. Controlled by the **ROCKER**, the pointer is an important tool that can be used to pan to other map locations, mark and edit waypoints and routes, and review location data of on-screen map items and waypoints.

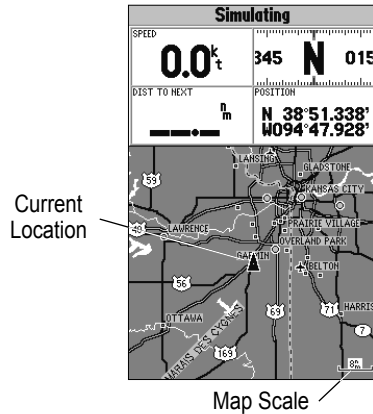

To pan the map:

1. Use the **IN/OUT** keys to select a map scale.
2. Use the **ROCKER** to move the pointer. A data field appears at the top of the display showing the bearing and distance from your boat to the pointer, along with the latitude and longitude of the pointer.
3. Press **QUIT** to re-center your boat on the map.

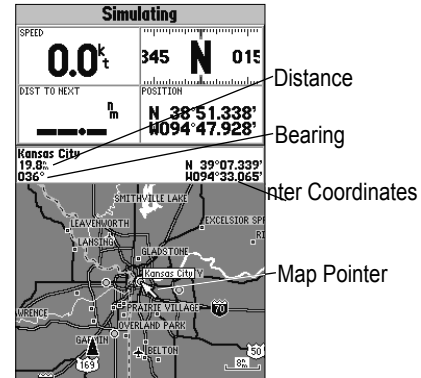

The map display actively scrolls or pans, enabling you to explore areas around the world and create waypoints and routes. Pressing **QUIT** returns the map to your present location.



NOTE: When the pointer reaches the edge of the map, the unit may pause as it loads new map data.

Creating and Using Waypoints

The GPSMAP 182/182C stores up to 3,000 alphanumeric waypoints with a user-defined symbol, comments, and depth available for each waypoint. Waypoints can be created using two basic methods.

ENTER/MARK Key—marks your present location, and provides options to select a map location or map item from the map display. You can also enter a new waypoint's location coordinates manually.

Graphically—defines a new waypoint location from the map display using the **ROCKER**.

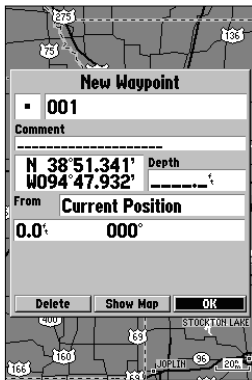

ENTER/MARK Key

The GPSMAP 182/182C's **ENTER/MARK** key quickly captures your present location to create a new waypoint. You must have a valid position (2D or 3D) fix to mark your present position. This can be determined by looking at the GPS tab on the Main Menu. When you move the pointer over a map item, a highlighted description of that item appears. You can also use this option to manually enter waypoint coordinates.

To mark your present position:

1. Press and hold **ENTER/MARK** until the **New Waypoint** window appears, and release it. A default three-digit name and symbol is created for the new waypoint.
2. To accept the waypoint with the default name and symbol, press **ENTER** to confirm the highlighted **OK** prompt.
3. To enter a different name, highlight the name field and press **ENTER**, then use the **ROCKER** to enter the new letter/numbers, and press **ENTER** when finished. Use up to 10 alphanumeric characters for the name.
4. To select a different symbol, highlight the symbol field to the left of the name, and press **ENTER**. Use the **ROCKER** to highlight the new symbol, and press **ENTER**.

5. To enter optional comments or a depth, highlight the **Comments** or **Depth** field to the right of the location coordinates and press **ENTER**, use the **ROCKER** to enter a value, and press **ENTER**.
6. To manually enter a set of coordinates, highlight the coordinates and press **ENTER**, use the **ROCKER** to enter the new coordinates, and press **ENTER** when finished.
7. When finished, use the **ROCKER** to highlight **OK**, and press **ENTER** to save the waypoint into memory.

Creating Waypoints Graphically

Waypoints can also be created from the map display. To mark a map location or map item, select the location or item with the pointer and press **ENTER/MARK**. When selecting a location or map item, a description of the point, its distance and bearing from your current location and the latitude/longitude of the pointer are displayed along the top of the map.

To create a new waypoint graphically:

1. Use the **ROCKER** to move the pointer to the map location. If you want to create the new waypoint at an on-screen map item, highlight the map item on the display.
2. Press and release **ENTER/MARK** to capture the pointer location. Do not hold the button down, as doing so marks your present location, not the map location.
If you are not using a map item to create a waypoint, go to step 4.
3. Highlight **Create Wpt** or **OK**, and press **ENTER**.
4. To accept the waypoint with the default name and symbol, press **ENTER**.
5. To change the name, symbol, or add a comment or depth, highlight the appropriate field, and press **ENTER**. Make your changes, and press **ENTER** when finished.
6. After entering and confirming your changes, move the highlight back to **OK**, and press **ENTER**.

Man OverBoard (MOB)

The GPSMAP 182/182C's Man OverBoard (MOB) function simultaneously marks and sets a course to a location for quick response to emergency situations.

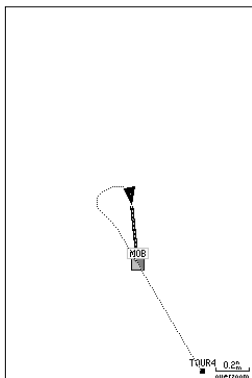

The MOB function allows you to quickly activate navigation back to a location.

To activate the MOB function:

1. Press the **MOB** key.
2. Press **ENTER** to confirm and begin navigating to the MOB location.
3. To stop navigation to the **MOB** location, press **NAV**, highlight **Stop Navigation**, and press **ENTER**.

When a MOB has been activated, a MOB waypoint with an international MOB symbol is created and the unit is on an active navigation to that point. Use any of the Navigation pages to guide you back to the MOB point. The MOB waypoint is stored in the waypoint list and you can delete or edit like any other waypoint.

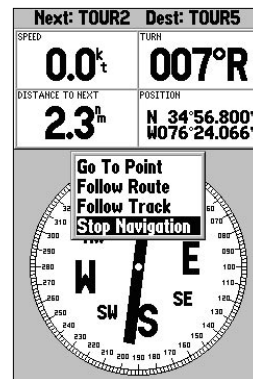

To stop navigation, highlight **Stop Navigation**, and press **ENTER**.

Reviewing and Editing Waypoints

When you have created and stored a waypoint, it can be reviewed, modified, renamed, moved, or deleted at any time through the Waypoint Edit Page. The Waypoint Edit Page is available for any stored waypoint by selecting the waypoint on the map, or selecting it from the waypoint lists under the **Points** tab on the Main Menu.

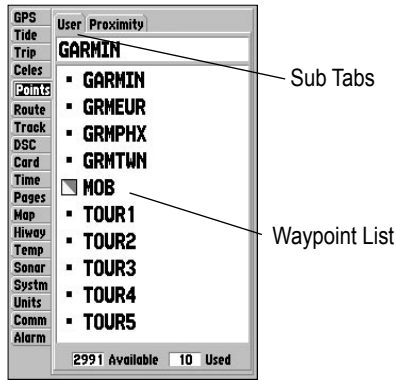

To access the Waypoint Edit Page:

1. Use the **ROCKER** to highlight a waypoint on the map.
Or
Press **MENU** twice, highlight the **Points** tab, and then highlight a waypoint from the **User** or **Proximity** lists.
2. Press **ENTER** to display the Waypoint Edit Page.

3. From the Waypoint Edit Page, you can change the name, symbol, comment, location coordinates, or depth for the selected waypoint. When the changes are made, highlight **Next**, and press **ENTER** to save them, or press **QUIT**.

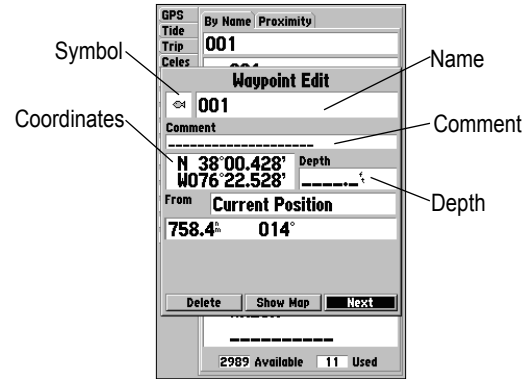

Waypoint Edit Page

To change the waypoint name:

1. Highlight the waypoint name field, and press **ENTER**.
2. Use the **ROCKER** to enter a new name, and press **ENTER** when finished.

To change the waypoint symbol:

1. Highlight the waypoint symbol field to the left of the waypoint name, and press **ENTER**.
2. Use the **ROCKER** to select a new symbol and press **ENTER**.

To change the Comment, Location, Coordinates, or Depth:

1. Highlight the field, and press **ENTER**.
2. Use the **ROCKER** to edit/enter the data. To move to the next line, press right on the **ROCKER**.
3. Press **ENTER** when finished.

To move the waypoint on the map:

1. From the Waypoint Edit Page, highlight **Show Map** and press **ENTER**.
2. Highlight the waypoint, and press **ENTER**. A **MOVE** label now appears under the pointer arrow in addition to a distance, bearing, and coordinate window. You can also use the **IN** and **OUT** keys to zoom the map. The map scale appears in the lower right corner.
3. Use the **ROCKER** to point to the new location, and press **ENTER**.
4. To stop the move process, press **QUIT**.

Navigating to a Destination

Using the Nav Key

The NAV key provides three ways to navigate to a destination: Go To Point, Follow Route, and Follow Track (TracBack). When you are actively navigating, you see a straight line that runs from your current location to the destination. The Go To option is the easiest method for selecting a destination. A Go To allows you to select a destination point and quickly set a direct course from your present location. If you have a point highlighted on a list or the map or if you are already navigating to a point, **Go To <point name>** appears in addition to **Go To Point**. The Go To function can be accessed from any list of points or graphically from the map.

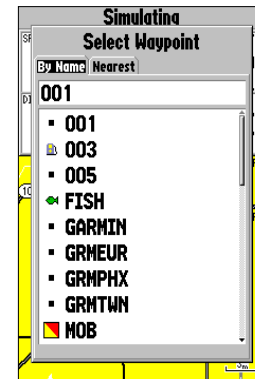

To activate a Go To from a point list:

1. Press the **NAV** key. Highlight **Go To Point**, and press **ENTER**.
2. From the **Find** menu, highlight **Waypoints**, and press **ENTER**. (You can also choose to go to other points, such as Cities or Tide Stations from this list.)
3. To select a waypoint from the waypoint lists, use the **ROCKER** to highlight either the **By Name** or **Nearest** tab, select a waypoint, and press **ENTER**.

Or

To select a waypoint from the map, highlight either the **User** or **Nearest** tab and press **MENU**. With **Select From Map** highlighted, press **ENTER**. Use the zoom **IN** and **OUT** keys and the **ROCKER** to select a waypoint, then press **ENTER**.

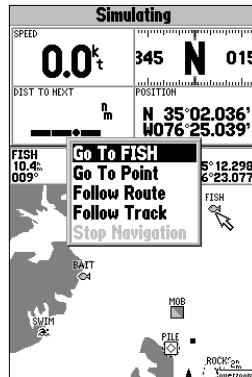

Selecting a Go To Graphically

A graphical Go To can be used to select one of three items from the map display: an existing waypoint, on-screen map items such as roads, rivers, cities, and nav aids, or a new map point. If you are selecting a map item as the Go To destination, the GPSMAP 182/182C automatically uses the name of the map item, but the point is not stored in the waypoint list. See page 21 for creating waypoints using map items. If you are selecting a new map point (non-map item) as the Go To destination, the GPSMAP 182/182C automatically creates a waypoint at the pointer location.

To activate an existing waypoint or map item as a Go To from the map display:

1. Use the **ROCKER** to highlight the waypoint or map item on-screen, and press **NAV**.
2. Highlight **Go To <waypoint name>**, then press **ENTER**.
Or
 1. Highlight the waypoint or map item, press **ENTER**.
 2. Highlight **Go To** from options at the bottom of the window, and press **ENTER**.

To Go To a new map point (non-map item):

1. Use the **ROCKER** to move the map pointer to a location.
2. Press **NAV**.
3. With **Go To MAP Point** highlighted, press **ENTER**.

**TracBack Navigation (Navigating a Track)**

The TracBack function allows you to retrace your path using the track log automatically stored in the receiver's memory. This feature eliminates the need to store waypoints along the way. TracBack routes are created by reducing your track log into a route of up to 254 turns and activating an inverted route along those points. When activated, a TracBack route leads you back to the oldest stored track log point, so it's a good idea to clear the existing track log before you start your current trip.

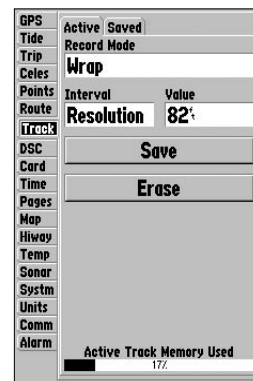
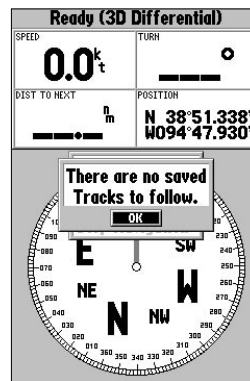

You must save a track before using the **Follow Track** option.

To clear the track log and define a starting point for a TracBack route:

1. Press **MENU** twice to display the Main Menu.
2. Using the **ROCKER**, highlight the **Track** tab, and highlight the **Active** sub tab to the right.
3. Use the **ROCKER** to select the **Erase** option, and press **ENTER**.
4. Highlight the **OK** field, and press **ENTER**.

You must first save the track log before you can use the **Follow Track** feature. The Save feature allows you to store up to 15 track logs from certain times and dates.

To save a track log:

1. From the Main Menu, use the **ROCKER** to highlight the **Track** tab, and highlight the **Active** tab to the right.
2. Use the **ROCKER** to select **Save**, and press **ENTER**.
3. From the **Save Back Through** window, highlight time, date, or Entire Log and press **ENTER**. When the track has been saved, the **Save Track** window is displayed. The default name, distance, number of points (500 max), and color is displayed in the **Save Track** window.

To change the name of the saved track, highlight the name field, and press **ENTER**. Then make your changes, and press **ENTER**.

To display the track on the Map and Highway Pages, highlight the check box to the left of **Show on Map and Highway**, and press **ENTER**.

To view the track on the map, highlight **Review on Map** and press **ENTER**. Pressing **MENU** on this page activates the options to **Measure Distance** (see page 32) and **Point to on Main Map**. Press **QUIT** to return to the Save Track window.

4. Highlight **OK** and press **ENTER** to save the track. Press **QUIT** to exit.

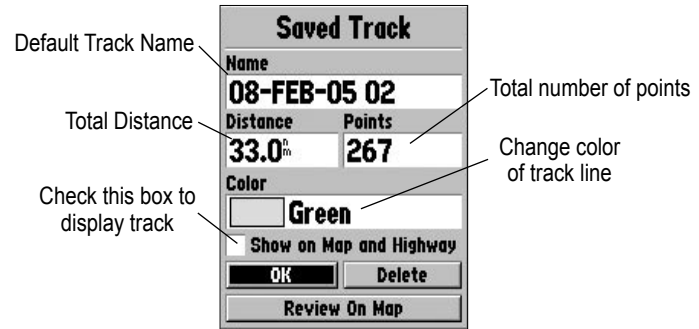

To activate a TracBack using the NAV key:

1. Press **NAV**, highlight the **Follow Track** option, and press **ENTER**.
2. Highlight the track you want to follow, and press **ENTER**.
3. Choose **Original** to navigate from the start to the end of your trip, or choose **Reverse** to navigate from the end to the start of your trip, and press **ENTER**.
4. To stop TracBack navigation, press **NAV**, highlight **Stop Navigation**, and press **ENTER**.

When a TracBack is active, the GPSMAP 182/182C takes the track log currently stored in memory and divides it into segments called legs. Up to 254 temporary turns (BEGIN, TURN 1, TURN 2, TURN 3,....., TURN X, END) are created to mark the most significant features of the track log in order to duplicate your exact path as closely as possible. To get the most out of the TracBack feature, remember the following tips:

- Always clear the track log at the starting point.
- The Record Mode option on the track log setup page must be set to Fill or Wrap.
- There must be at least two track log points stored in memory to create a TracBack route.

- If the track log interval is set to the Time option, the route can not follow your exact path. For best performance, keep the interval set to resolution.
- If the receiver is turned off or satellite coverage is lost during your trip, the TracBack draws a straight line between any point where coverage was lost and where it resumed.
- If the track log's changes in distance and direction are too complex, 254 waypoints may not mark your path accurately. The receiver then assigns the 254 waypoints to the most significant points of your track, and simplifies segments with fewer changes in direction.

For more information on setting up the Track options and saved tracks, see page 59.

Routes

The last way to navigate to a destination is to create a user-defined route. The GPSMAP 182/182C allows you to create and store up to 50 reversible routes (numbered 1-50), with up to 254 waypoints each. Routes can be created and modified in two ways. The first method is to create the route using a map page. This method allows you to select points on the map and see each route leg as it is created. The second method is to enter the waypoint names as text on the Route Review Page. You to see a list of the waypoints as you create the route. All of the route functions are accessed through the Main Menu or the NAV key.

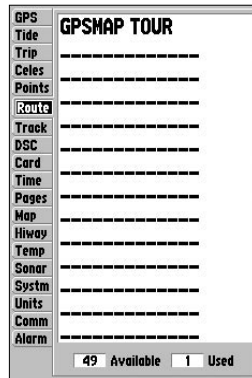

Route Tab and Route Options Menu

To create a route using the Route Edit Map Page:

1. Press **MENU** twice to display the Main Menu.
2. Use the **ROCKER** to highlight the **Route** tab and press the **MENU** key to display the route options page, or highlight the first available blank route slot, and press **ENTER**. (Skip to step 4 if you use this method.)
3. Select the **New Route** option, and press **ENTER**.
4. To add an existing waypoint or map item to the route, use the pointer to select the waypoint or map item, and press **ENTER**. Map items do not appear in the waypoint list. To create a waypoint from a map item, see page 21.
5. To add a new waypoint to the route, use the map pointer to select the map location, and press **ENTER**. Press **ENTER** again to confirm the new waypoint. You can also change the name and symbol of the new waypoint (see page 8).
As you add each new waypoint to the route, the data window at the top of the map display shows the waypoint/map item name, bearing and distance from your location, and coordinates of the pointer. The bottom of the display shows the number of available and used points. A route line appears on the map to indicate each completed leg, and a dotted line appears indicating the distance and bearing to the arrow pointer from the last route waypoint.
6. Repeat steps 4 and 5 until you have finished defining all route waypoints.

- When finished, press **QUIT** twice to return to the **Route List** Page. Highlight **Edit as Text**, and press **ENTER** to return to the **Route Review** Page.

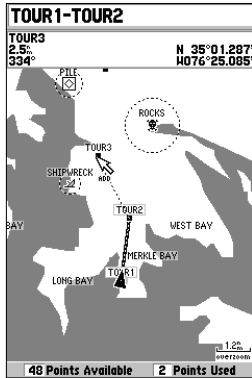

ADD appears below the pointer as you insert points.

To create a route using text on the Route Review Page:

- Press **MENU** twice to display the Main Menu.
- Use the **ROCKER** to highlight the **Route** tab and press **MENU** to display the route options page, or highlight the first available blank route slot, and press **ENTER**. (Skip to step 4 if you use this method.)
- Select the **New Route** option, and press **ENTER**.
- Press **MENU**, select **Edit as Text**, and press **ENTER**.
- Use the **ROCKER** to highlight the first field under the word **Waypoint**, and press **ENTER**.

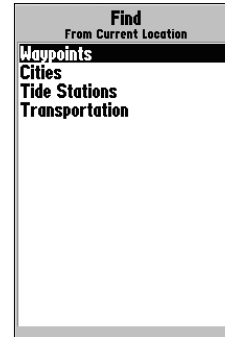

Choose the category you want to add a route point from.

6. From the **Find** menu, highlight **Waypoints**, and press **ENTER**. You can also choose from other categories, such as Cities or Tide Stations from this list. From either the **By Name** or **Nearest** tab lists, choose the waypoint you want and press **ENTER**. (See page 50 for searching for waypoints by name.)
7. From the **Waypoint Review** Page, **OK** is automatically highlighted. You can use the **Show Map** option to view the point on the map, and then press **QUIT** when finished viewing to return to the **Waypoint Review** Page. Press **ENTER** to add the point to the route. The next field automatically highlights.
8. Repeat steps 5-7 until all the route points are entered. Press **QUIT** to return to the Route List Page.

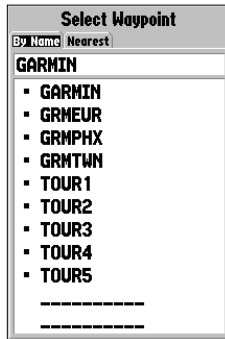

Choose a waypoint from either the **By Name** or **Nearest** tab list.

Find

Use the **FIND** key to search the unit for user waypoints, map items and any BlueChart or MapSource information loaded to the unit or on a data card. Press **FIND** to display a list of available find categories. The default items are Waypoints, Cities, Tide Stations, and Transportation. If you press **FIND** and are in Pan Mode, the unit centers its search from the location where the map pointer is located.

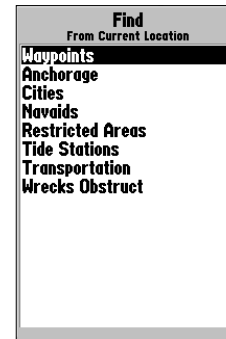

Find Items List

To Find an item from your current location:

1. From any page, press **FIND**.
2. Using the **ROCKER**, highlight the category from a list, and press **ENTER**.
3. For Waypoints and Cities, search using **By Name** or **Nearest**. Use the **ROCKER** to highlight a sub tab. For **By Name**, use the top field to spell out the name or scroll down through the list. (See page 8 for steps on entering a name.)

To Find an item from other locations:

1. From the Map page, use the **ROCKER** to pan to a location, and press **FIND**.
2. Using the **ROCKER**, highlight a category from the list, and press **ENTER**.

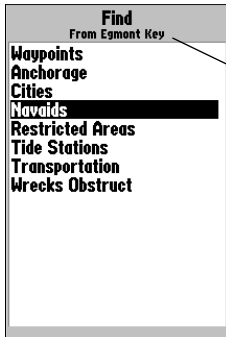

You can also Find from items found on the Find List.

The Find option also supports a “find from” feature that allows you to center your search around an item you have just found. For example, you search for “Restricted Areas” and you find a point named “Anchoring Prohibited.” If you press **FIND** again, “From Anchoring Prohibited” appears as the new search from the point.

Also, use the Find feature to center your search from any waypoint, route list entry, map item, or tide station. Highlight the item you want to find from, and press the **FIND** key.

- **Nearest To Boat**—centers search from your boat’s current location.
- **Nearest To Other**—centers your search around another map location.
- **Nearest To Next**—centers search from the next point of your active route.
- **Nearest To Destination**—centers search from the last point of your active route.

To Find an item using the Find options:

- 1 From any page, press **FIND**.
- 2 Using the **ROCKER**, highlight a category from the list, and press **ENTER**.
- 3 From the search results list, press **MENU**, highlight an option, and press **ENTER**.

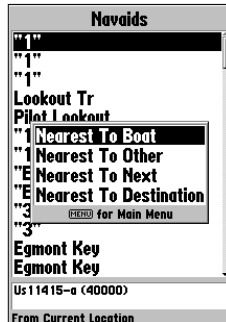

Find Menu Options

Additional Information

Items located using the Find feature have information about the point available. The information varies depending on the type of data loaded on the optional data card. Tabs along the top of the detail window contain the information available for the item. Any additional options are displayed along the bottom.

To view additional information for a Find item:

1. From the **Find** list, highlight an item, and press **ENTER**.
2. Use the **ROCKER** to highlight the individual tabs and show the information. To view all of the information, highlight the field, and press **ENTER**. Use the **ROCKER** to scroll through the text, or press **MENU** and choose a scroll option.

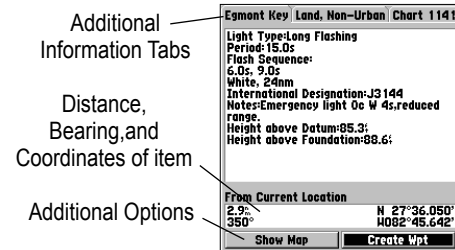

Information Window

DSC

The DSC tab on the Main Menu allows you to control and set up the Digital Selective Calling (DSC) features on the GPSMAP 182/182C.

Digital Selective Calling (DSC) uses marine VHF radio and Global Positioning System (GPS) technologies to transmit and receive location information. The chartplotter repeats the call properties received from the VHF radio on the chartplotter. The GPSMAP 182/182C requires input from a DSC enabled VHF radio to display position, and sound/display alerts from a Distress Call or Position Report. Conversely, the VHF radio requires input from a GPS to transmit position coordinates for a Distress Call or Position Report. For connection information, refer to “Connecting the Power and Data” on page 98.

An emergency DSC Distress Call allows a vessel in trouble to transmit a substantial amount of information in a single transmission or call, without the need for voice communication. When any nearby rescuer receives the DSC signal, an alarm sounds and they immediately receive the location of the caller. The rescuer can then choose to navigate to the caller’s location to assist, or forward the call on to the Coast Guard. When the Coast Guard receives the call, they can immediately access the caller’s

information (such as who they are and the type of vessel) in their database while they are in transit to the caller’s location.

A non-emergency DSC Position Report allows mariners to exchange and display the positions of one another. When a DSC position is received, the mariner can choose to create a waypoint or to show the received location on an electronic map.

Anytime a vessel receives a DSC call, they can store and quickly navigate to that location using a Go To. This makes DSC a time saver, especially in an emergency situation. To use DSC, a user must first register their VHF radio with the FCC and receive a Maritime Mobile Service Identity (MMSI) number.

For more information about Digital Selective Calling and Maritime Mobile Service Identity (MMSI) numbers, refer to page 103 in the “Appendix.”

Understanding Distress Calls

When the GPSMAP 182/182C receives a Distress Call from a connected DSC-enabled VHF radio, an alert message and notification page appear, and an alarm tone sounds. Distress Calls are shown in the DSC Call List and Log with a checkered symbol.

Understanding Position Reports

A Position Report is similar to a Distress Call except no alarm is sounded. Position Reports are not broadcast to all DSC users and are shown with a boat symbol.

Distress Call		DSC Position Report	
MMSI	00000001	MMSI	00000001
Name	-----	Name	-----
Receiving Time	29-MAY-05 05:19:28 ^z	Receiving Time	29-MAY-05 05:21:15 ^z
From Current Position		From Current Position	
G: 357 ^z	N 38°51.338'	G: 357 ^z	N 38°51.338'
	W094°47.929'		W094°47.929'
Delete	Show Map	Create Wpt	Delete
			Show Map
			Create Wpt

Receiving DSC Calls

Each time you receive a Distress Call or Position Report, a Notification Page appears, and the call is placed in the DSC Call List and Log. The Notification Page contains information about the call including the type of call (distress or position report), the MMSI number of the caller, a user definable name, the time and date of the call, the Bearing and Distance from your current position, and the coordinates of the caller. To see the caller's location on a map, select the **Show Map** button. To create a waypoint at the caller's location, select the **Create Wpt** button. To close the Notification Page, press the **QUIT** key.

When a Distress Call or Position Report is placed in the Call List and Log, the information on the Notification Page is retained. To review a DSC call or log entry, highlight the entry, and press **ENTER**. The DSC Entry Review Page is identical to the Notification Page with one exception, the entry can be deleted.

DSC Entry Review	
MMSI	00000001
Name	-----
Receiving Time	29-MAY-03 05:21:15 ^z
From Current Position	
G: 357 ^z	N 38°51.338'
	W094°47.929'
Delete	Show Map
	Create Wpt

DSC Entry Review Page

To review a call or log entry:

1. Press **Menu** twice.
2. Open the Call List or Log from the **DSC** tab.
3. Press up or down on **ROCKER** to highlight the call you want to review.
4. Press **ENTER** to open the **DSC Entry Review** Page.

DSC Call List

The DSC Call List displays the 50 most recent calls, even if the unit is left unattended. The Call List displays the most recent call from a vessel. If a second call is received from the same vessel, it replaces the first call in the Call List. Press **MENU** to sort the list and delete entries.

DSC Log

When DSC calls are received, they are automatically placed in the Log, with the most recent call at the top. The unit can log up to 100 calls. When 100 calls are logged, the oldest log is removed when a new call is received. Press **MENU** to sort the list and delete entries.

DSC Directory

The DSC Directory acts much like a phone book and can hold up to 50 entries. Pressing **MENU** from this page displays options to add a **New Item**, **Delete** a highlighted entry, or **Delete All** entries.

To add a new Directory entry:

1. Open the **DSC Directory** in the Main Menu.
2. Use the **ROCKER** to highlight the first blank space in the directory list, and press **ENTER**.

Or

Press **MENU**, highlight **New Item**, and press **ENTER**.

3. Enter the MMSI number, a Name, and any comments.
4. When finished, highlight **OK**, and press **ENTER**.

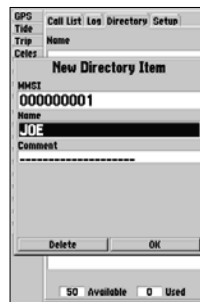

New Directory Item Page

When a Distress Call, Position Report or Directory item is named, the name is attached to that particular MMSI number. If a name is used, all DSC entries of the same MMSI number will show the name.

Navigating to a Position Report or Distress Call

After a Position Report or a Distress Call is received, navigation can be quickly set to the call location.

To navigate to Position Report or Distress Call:

1. Press the **NAV** key.
 2. With **Go To** (MMSI/Name) highlighted, press **ENTER**.
- Or
1. Highlight the call on the **Call List** or **Log**, and press **NAV**.
 2. With **Go To** (MMSI/Name) or (DSC) highlighted, press **ENTER**.

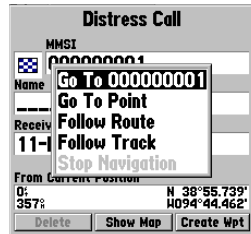

Navigating to a DSC Call

Setting up DSC

The DSC Setup sub tab allows you to turn DSC **On** and **Off**. This Setup tab also allows you to simulate Distress Calls and Position Reports while the unit is in Simulator Mode (see page 3). Simulating calls is helpful for practice before connecting to the real system. The Distress Call simulator also helps to check if alarms are working properly.

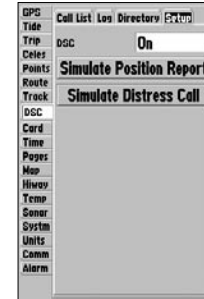

DSC Setup

MAIN PAGES

Five main display pages are always available: Map Page, Pointer Page, Numbers Page, Highway Page, and Active Route Page. You can cycle through these pages by pressing either **PAGE** or **QUIT**. If you have an external Sonar Module with transducer connected to the GPSMAP 182/182C, a Sonar Page is inserted between the Map Page and Pointer Page. For more information on the Sonar Page, refer to the “Using Sonar” section on pages 78-91.

With the Map Page displayed, press **PAGE** several times. Each time you press **PAGE** the next main page is appears. Do the same with the **QUIT** key. **QUIT** acts the same as **PAGE**, except the pages are displayed in a reverse sequence.

Each main page has an options menu. Options menus contain the setup options and functions that apply to that page. Press **MENU** to display the options menu. Use the **ROCKER** to select an item from the options menu and press **ENTER**. Many of the menus in the GPSMAP 182/182C are arranged in a tab layout. Use the **ROCKER** to move left or right from tab to tab.

Notice that either **PAGE** or **QUIT** stops the current function and returns you to the main page. If you find yourself lost in a menu or you start a function you do not want, press **PAGE** or **QUIT**.

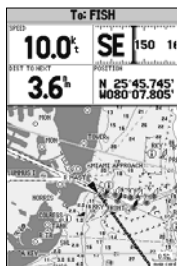

Map Page

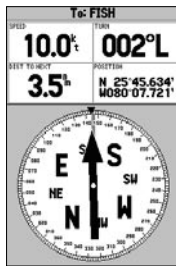

Pointer Page

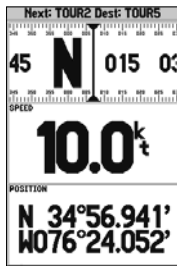

Numbers Page

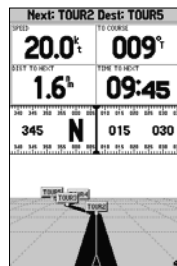

Highway Page

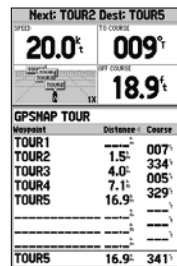

Active Route Page

Map Page

The Map Page provides a comprehensive display of electronic cartography, plotting, and navigational data. When in the BlueChart data coverage area or using optional MapSource software, the map display shows your boat on a digital chart, complete with geographic names, map items, nav aids, and a host of other chart features. It also plots your track and displays any routes and waypoints you create. A map pointer allows you pan and scroll to other map areas, determine the distance and bearing to a location, and perform various route and waypoint functions.

When the pointer is active, an additional data window appears below the data fields to indicate the location, range, and bearing to the pointer, a selected waypoint, or map item. The map scale displays at the bottom right of the page.

The Zoom **IN** and **OUT** keys combined with the **ROCKER**, allow you select zoom ranges and move the pointer. Two basic map operating modes, Position Mode and Pointer Mode, determine what cartography is shown on the map display. Position Mode moves the cartography to keep the present position marker within the display area. Pan Mode moves the cartography to keep the map pointer within the display area.

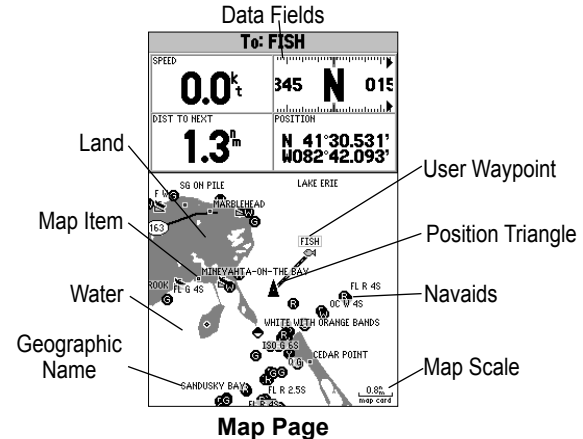

The GPSMAP 182/182C system starts in the Position Mode, with your location centered on the map display. When sufficient map coverage is not available to keep your location centered, the position triangle moves toward the edge of the display.

Pan Mode starts when the **ROCKER** is pressed. The pointer is moved over the map display using the **ROCKER**. When the pointer reaches the edge of the display, the map scrolls forward under the pointer.

Using the Map Pointer

The pointer pans away from your present location (even outside of your current detail coverage.) As you pan past the edge of the current map display, the screen actively scrolls forward to provide continuous map coverage. An hourglass symbol appears by the pointer while the unit is busy drawing new map details.

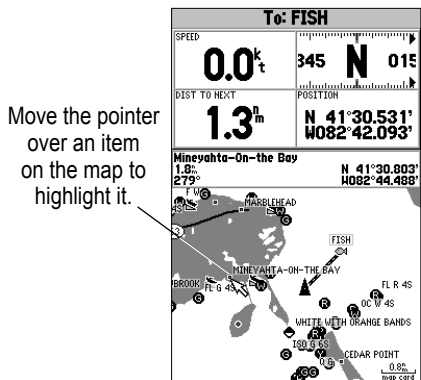

As you move the pointer, the distance and bearing from your present location to the pointer is displayed in the data window, along with the pointer's location coordinates. Keep in mind that when the pointer is stationary, the distance and bearing from your present position changes as your location moves. The pointer can also be used to view on-screen waypoint and map item properties directly from the map display.

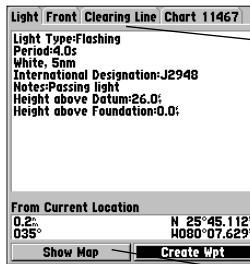

Additional Information Tabs

Pressing **ENTER** while highlighting a map item brings up additional details and options.

Additional Options

To select an on-screen waypoint or map item with the map pointer:

1. Use the **ROCKER** to move the map pointer to a waypoint or map item. (If there are several waypoints grouped closely together, zoom in closer for a better view.)
2. When a waypoint or map item is selected, it is highlighted on-screen, with the name and location displayed. Press **ENTER** to show details of the map item. When in the BlueChart coverage area or using optional MapSource data, additional information tabs appear. Use the **ROCKER** to highlight the individual tabs, and display additional information and options.
3. Press **QUIT** to re-center your location on-screen.

Use the pointer to create new waypoints directly from the map.

To create a waypoint with the pointer:

1. Use the **ROCKER** to move the pointer to the map location.
2. Press **ENTER**. The **New Map Waypoint** window appears. (If the pointer is on a map item, you can access details about the item by pressing **ENTER**.)
3. Press **ENTER** while **Create Wpt** is highlighted.
4. Press **ENTER** to confirm the new waypoint using the default three-digit name and symbol.

For more information about waypoints, see page 8.

Selecting Map Zoom Range

The map display has 28 available zoom ranges from 20 ft to 800 mi (5 m to 1200 km.) The map scale is controlled by the **IN** and **OUT** keys, with the current scale displayed at the bottom right of the data window.

To select a map zoom range:

Press the **OUT** key to zoom out and the **IN** key to zoom in.



***NOTE:** The scale value represents the distance from one end of the scale bar to the other.*

Using Built-In Basemap

Using BlueChart/MapSource Data

Overzoom, no additional data is available

The GPSMAP 182/182C's system has a built-in worldwide database to 20 mi, with more detailed coverage available through the use of the BlueChart or MapSource data. The GPSMAP 182/182C displays cartography as long as there is chart information available for the range you have selected. Map coverage conforms to the following conditions:

- When the selected zoom range is covered by the internal database, BlueChart, or MapSource data, cartography is displayed.
- When the selected zoom range is covered by both the internal database and BlueChart/MapSource data, cartography is displayed using the data with the best resolution.
- When the selected zoom range exceeds the resolution of the data in use, an **Overzoom** warning appears below the scale.

Map Page Options

Many features of the GPSMAP 182/182C are menu driven. Each main page has an options menu, allowing you to customize the corresponding page to your preferences and/or select special features that specifically relate to that page. The data window, located at the top of the main pages, provides a user-selectable layout of various types of useful data. Each data field can be configured to display any one of several data options. The data window layout can be configured to display additional data fields and change the size of the data displayed.



The Map Page provides access to functions and features relating to the Map Page and layout options.

To display and select the Map Page options:

1. Press **MENU**.
2. Use the **ROCKER** to highlight an option, and press **ENTER**.

The available options are Full Screen Map/Show Data, Change Numbers, Measure Distance, Show Sonar (If equipped with an external Sonar Module, see the "Using Sonar" section on pages 78-91 for details on this feature,) Set Up Map and Turn Declutter on/off. Following are details on using each of these options.

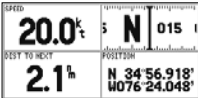
You can also choose to merge the four medium default data fields to a single, large field for better readability or you can split any or all of the default data fields to show four small data fields.

Single, large data field	
Default, medium fields	
Split, small fields	

Measure Distance—measures the bearing and distance between any two points on the map display.

To measure the bearing/distance between two points:

1. Highlight **Measure Distance**, and press **ENTER**. An on-screen pointer labeled **ENT REF** appears on the map display at your present location.
2. Move the pointer to a reference point (the point that you want to measure from), and press **ENTER**.

3. Move the pointer to the end measurement point. The bearing and distance from the reference point and pointer coordinates appear in the data window at the top of the display. Press **QUIT** to finish.

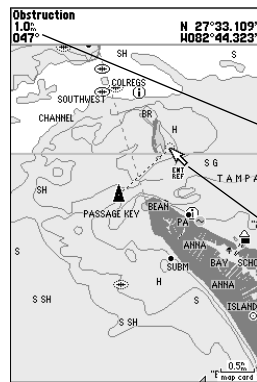

The map shows a pointer at a location with the following data displayed at the top right:

- Pointer Coordinates: N 27°33.109', W 082°44.323'
- Distance and Bearing: N 34 56.918', W 076 24.048'

Other map features include labels for 'Obstruction', 'SOUTHWEST CHANNEL', 'PASSAGE KEY BEACH', 'ANNA BAY', and 'ANNA ISLAND'. A scale bar at the bottom right indicates 0.5% map scale.

Full screen map shown.

Set Up Map—configures the map display preferences, including map detail, map orientation, automatic zoom, and various map items and points. Refer to “Main Menu Map Tab” on page 64 for more information.

- **Defaults**—restores settings back to factory settings for the tab highlighted.
- **All Map Defaults**—restores settings back to factory settings for all tabs.

To change a map setup feature:

1. From the Map Page menu, highlight **Set Up Map**, and press **ENTER**.
2. Press left or right on the **ROCKER** to highlight a tab, press up or down on the **ROCKER** to highlight the setting you want to change, and press **ENTER**.
3. Press up or down on the **ROCKER** to highlight to a setting, and press **ENTER**. To exit, press **QUIT**.

Turn Declutter On/Off—toggles between showing BlueChart spot soundings and map outlines for easier viewing.

Pointer Page

The Pointer Page provides graphic steering guidance to a destination waypoint, with an emphasis on the bearing to your destination and current direction of travel. The middle of the page features a rotating compass ring that shows your course over ground (track) while you are moving, and a bearing pointer that indicates the direction of the destination (bearing) relative to the course over ground. The compass ring and pointer arrow work independently to show—at a glance—the direction of your movement and the direction to your destination. For instance, if the arrow points up, you are going directly to the waypoint. If the arrow points any direction other than up, turn toward the arrow until it points up—then continue in that direction.

The current speed, distance to the next waypoint, turn angle and current location are displayed at the top of the screen. This page provides better steering guidance when traveling at slower speeds and/or when making frequent directional changes. When you are not navigating to a waypoint, the compass ring shows the current direction of travel but the arrow does not appear.



NOTE: *The bearing pointer, bearing bug, and compass ring may point in various directions when you are stationary or at very low speeds. When you start moving, the pointer is correct.*

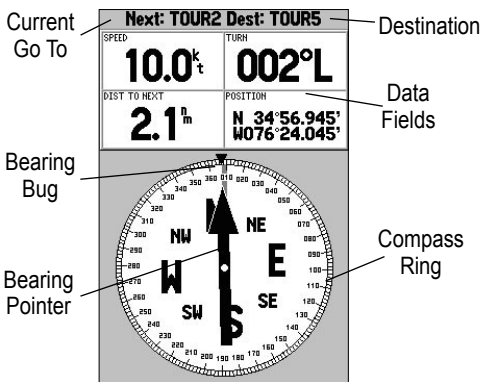

The Pointer Page features a menu page that provides access to layout and data field options. The data window, located at the top of the page, provides a user-selectable layout of various types of useful data. Each data field can be configured to display several data options. The data window layout can be configured to display additional data fields and change the size of the data displayed.

To display and select the Pointer Page options:

1. Press **MENU**.
2. Use the **ROCKER** to highlight an option, and press **ENTER**.
For detailed instructions on changing the data fields and layout of the Pointer Page, see page 31.

Numbers Page

The Numbers Page allows for precision navigation to 1 degree of steering. The default page displays three large numbers fields. You can customize the Numbers Page to display the size and number of fields along with the type data you want to see. See page 31 for instructions on changing the data fields.

The Numbers Page provides a quick reference for the important data you want to display. By default, the page displays three large, user-selectable data fields showing a compass ribbon, speed, and current location coordinates. You can also choose to show the three data fields in large lettering for better readability or you can split any or all of the data fields to show four smaller data fields. See page 31 for detailed instructions on changing the data fields and layout of the Numbers Page.



Numbers Page
shown with middle
data field split into
four fields

To split the data fields:

1. Press **MENU**, and press **ENTER**.
2. Highlight a data field, and press **MENU**.
3. Highlight **Split Numbers**, and press **ENTER**. Four new data fields appear. Press **QUIT** to finish.
4. To return to the original configuration, repeat steps 1 and 2, but instead of **Split Numbers**, select either **Merge Numbers** or **Defaults**. Press **QUIT** to finish.

Highway Page

The Highway Page provides graphic steering guidance to a destination waypoint, placing greater emphasis on your straight-line course, and the distance and direction you are off course. As you head toward your destination, the middle of the screen provides visual guidance to your waypoint on a moving graphic highway. Your present location is at the bottom center of the highway display. The line down the middle of the highway represents your course. As you navigate toward a waypoint, the highway moves—indicating the direction you are off course. To stay on course, steer toward the center of the highway.

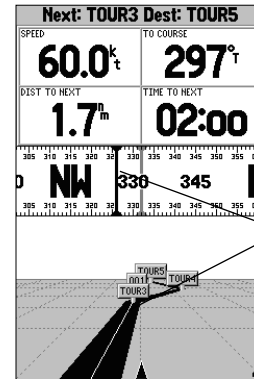

Steer toward
the center of the
highway or toward
the black vertical
bar on the compass
ribbon to get back
on course.

The four data fields at the top of the page provide additional user-selectable guidance information. Additionally, a compass ribbon shows your current heading along with a dark, vertical bar that indicates the direct bearing to the navigation point. When the dark, vertical indicator (or arrow) lines up with the lighter red bar in the middle, you are heading directly to the navigation point. Use the Highway Page as your primary navigation page in lieu of the Pointer Page when your main concern is following a defined course.

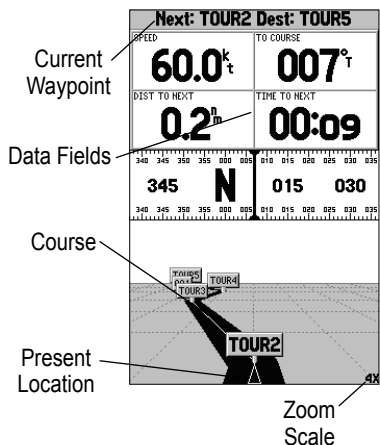

You can zoom in or out on the Highway display for a smaller or larger view. Five available settings range from 1X to 16X, with a default setting of 8X. The current scale appears in the bottom right of the display.

To zoom in or out on the highway display:

Press either the **IN** or **OUT** key to increase or decrease the zoom scale.

Highway Page Options

The Highway options page defines the data fields and selects the waypoints and tracks that are displayed. The data window, located at the top of the page, provides a user-selectable layout of various types of data. Each data field can be configured to display several data options. The data window layout can be configured to display additional data fields and change the size of the data displayed.

To display and select the Highway Page options:

1. Press **MENU**.
2. Using the **ROCKER**, highlight an option, and press **ENTER**.

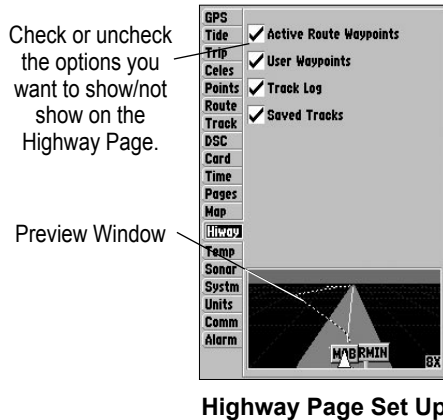

The following options are available from the Highway Page menu:

Set Up Highway—allows you to select what waypoints and tracks are shown on the Highway display. Use the **ROCKER** and **ENTER** keys to select/deselect options.

Change Numbers—specifies the type of data displayed in each data field used. For detailed instructions on changing the data fields and layout of the Highway Page, see page 31.

Active Route Page

The Active Route Page shows each point of the active route, with the point name, distance and choice of Course, ETA, Fuel, Leg Distance, Leg Fuel, Leg Time, Sunrise, Sunset, or Time To for each point from your present location. The current destination point is marked with an arrow icon. As you navigate a route, the waypoint list automatically updates to indicate the next active point first. The Active Route and Route Review Pages share many of the same features and options. For more information on the Active Route Page, see page 17.



NOTE: The Active Route Page appears when the unit is navigating to a destination using a route, TracBack, or Go To.

Next: TOUR2 Dest: TOUR5		
SPEED	TO COURSE	
30.0 ^k _t	008 ^t	
TOUR1	OFF COURSE	
TOUR2	26.6 ^f _t	
TOUR3	1X	
GPSMAP TOUR		
Waypoint	Distance	Course
TOUR1	---	---
TOUR2	0.2 ^h	007 ^t
TOUR3	2.7 ^h	334 ^t
TOUR4	5.8 ^h	005 ^t
TOUR5	15.6 ^h	329 ^t
---	---	---
---	---	---
---	---	---

Active Route Page

Active Route Page Options

The following options are available from the Active Route Page:

- **Hide/Show Numbers**—see page 31 for instructions (same as Map Page option).
- **Change Numbers**—see page 31 for instructions.
- **Edit on Map**—see page 17 for instructions.
- **Add Before**—see page 17 for instructions.
- **Remove**—removes points from a route.
- **Invert**—reverses the direction of the route.
- **Re-evaluate**—recalculates and reactivates the current route.
- **Invert**—reverses the route.

To invert an active route:

1. From the **Active Route** Page, press **MENU**.
2. Using the **ROCKER**, highlight **Invert**, and press **ENTER** to reverse the route.

Re-evaluate—reactivates the current route and selects the route leg closest to your current location as the active leg. The active leg defines the current from and to waypoints.

To re-evaluate an active route:

1. From the **Active Route** Page, press **MENU**.
2. Using the **ROCKER**, highlight **Re-evaluate**, and press **ENTER** to recalculate.

MAIN MENU

The Main Menu provides access to various waypoint, system, navigation, interface management, and setup menus. The 19 Menu tabs are divided into categories by function. The Main Menu is available from any page in the system, and is accessed by pressing **MENU** twice. See page 6 for additional instructions on changing settings and entering data.

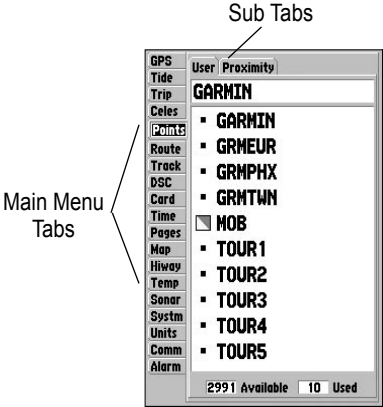

Main Menu

To select a Menu tab from the Main Menu:

1. Press up or down on the **ROCKER** to highlight a tab. The information for the highlighted tab automatically appears to the right. If you want to select any of the sub tab items, press right on the **ROCKER**, and press up or down to select individual items.
2. Either press **MENU** for additional submenu options, or press **ENTER** to make changes to the highlighted item. Press left on the **ROCKER** to get back to the Main Menu tabs list.
3. Press **QUIT** to return to the Main Menu.

GPS Tab

The GPS tab provides a visual reference of satellite acquisition, receiver status, and accuracy. The status information provides an idea of what the receiver is doing at any given moment. The sky view and signal strength bars give you an indication of what satellites are visible to the receiver and whether or not they are being tracked. The signal strength is shown on a bar graph for each satellite, with the satellite number below. As the receiver locks onto satellites, a signal strength bar appears for each satellite in view. The progress of satellite acquisition is shown in three stages:

- **No signal strength bars**—the receiver is looking for the satellites indicated.
- **Light signal strength bars**—the receiver has found the satellite(s) and is collecting data.
- **Dark signal strength bars**—the receiver has collected the necessary data and the satellite(s) are ready for use.

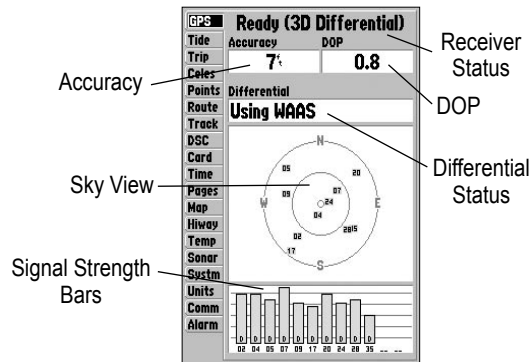

The status field indicates a 2D or 3D, when the GPSMAP 182/182C has collected the necessary data from satellites to calculate a fix. The unit then updates the location, date, and time.

You can use the sky view to help determine if any satellites are being blocked, and whether you have a current location fix (indicated by a 2D, 2D Differential, 3D, or 3D Differential in the status field). The sky view shows a bird's-eye view of the position of each satellite relative to the receiver's last known location. The outer circle represents the horizon (north up), the inner circle 45° above the horizon, and the center point a position directly overhead. You can also set the sky view to a Track Up configuration, causing the top of the sky view to align along your current track heading.

WAAS Capability

The GPSMAP 182/182C is capable of receiving WAAS (Wide Area Augmentation System) satellite signals. WAAS is an FAA (Federal Aviation Administration) funded project to improve the overall accuracy and integrity of the GPS signal for aviation use, but land/sea based users can also benefit from this system. At this time, the system is still in the development stage and is not fully operational.

There are currently two WAAS satellites that can be received in the U.S.A., one over the Atlantic Ocean and one over the Pacific Ocean, in a geo-stationary orbit over the equator. Effective use of the WAAS satellite signal may be limited by your geographic location in relation to those satellites, now in developmental service. WAAS satellite signal reception requires an absolute clear view of the sky and works best when there are no nearby obstructions such as buildings and mountains.

WAAS satellites are numbered 33 or higher when viewing the sky view on your GPSMAP 182/182C. Initial reception of the WAAS signal can take up to 15-20 minutes, then 1-2 minutes afterwards. When WAAS differential correction has been received for GPS satellites (numbers 32 or below), a D appears in the signal bar of the sky view and 2D or 3D Differential appears in the receiver status. To learn more about the WAAS system, its satellite positions and current state of development, visit the FAA web site (<http://gps.faa.gov>). Because WAAS requires CPU resources of the GPSMAP 182/182C to search for and track the satellites, you can disable the WAAS feature to improve unit performance if WAAS reception is not available in your area. Refer to the “Appendix” for more information.

To Disable/Enable WAAS capability:

1. From the **GPS** tab, press **MENU**.
2. Use the **ROCKER** to highlight **WAAS Off** or **WAAS On**, and press **ENTER**.

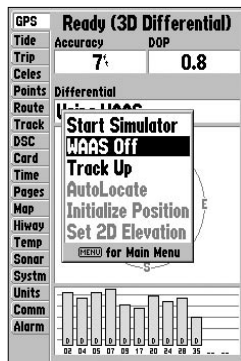

Highlight **WAAS Off**, and press **ENTER** to disable the WAAS capabilities.

- **AutoLocate**—the receiver is looking for any satellite whose almanac has been collected. This process can take up to five minutes.
- **Acquiring Satellites**—the receiver is looking for and collecting data from satellites visible at its last known or initialized position, but has not collected enough data to calculate a fix.
- **2D**—at least three satellites with good geometry have been acquired and a 2 dimensional position fix (latitude and longitude) is being calculated. “2D Differential” appears when you are receiving DGPS corrections in 2D mode and a D shows on the strength bar of satellites being corrected.
- **3D**—at least four satellites with good geometry have been acquired and your location is now being calculated in latitude, longitude and elevation. “3D Differential” appears when you are receiving DGPS corrections in 3D mode and a D shows on the strength bar of satellites being corrected.
- **Poor GPS Coverage**—the receiver is no longer tracking enough satellites for a 2D or 3D fix.
- **Receiver Not Usable**—the receiver is unusable, possibly due to interference or abnormal satellite conditions. Turn the unit off and back on to reset it.
- **Simulating**—the receiver is in Simulator Mode.

The Differential Receiver status shows one of the following:

- **Off**—No optional beacon receiver attached or enabled in the Comm menu or WAAS off.
- **Searching For WAAS**—WAAS is enabled and receiver is searching for WAAS signal
- **Using WAAS**—WAAS capability enabled and unit receiving WAAS corrections.
- **No Beacon Signal**—DGPS receiver attached, but not transmitting RTCM data to GPS.
- **Tuning Beacon**—receiver is tuning manual DGPS frequency.
- **Receiving Beacon**—unit is receiving DGPS corrections.
- **Scanning Beacon**—DGPS receiver is scanning for available frequency.

The Differential SNR (Signal to Noise Ratio) indicates, on a scale to 0-30db with 30db being the best, the strength of the DGPS signal being received. The SNR depends on the mounting of your DGPS receiver and the distance from the DGPS transmitting station. If no optional DGPS receiver is used with the GPSMAP 182/182C, the **DGPS Rcvr** field displays **Off**.

GPS Tab Options

The GPS tab features an options page that provides access to functions and features relating to the GPS Info display.

To display and select the GPS Tab options:

1. Press **MENU**.
2. Using the **ROCKER**, highlight an option, and press **ENTER**.



***NOTE:** If a DGPS receiver is attached to the unit and Garmin DGPS, RTCM In/NMEA Out, or Other DGPS is enabled on Port 2, WAAS is automatically disabled (WAAS off). It is not possible for the GPSMAP 182/182C to receive WAAS and DGPS corrections at the same time.*

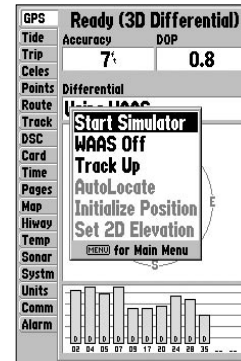

GPS Tab Options

Tide Tab

The Tide tab shows a graphical chart that displays tide station information in a 24-hour span starting at midnight station time. You can choose from different dates and more than 3,000 tide stations.

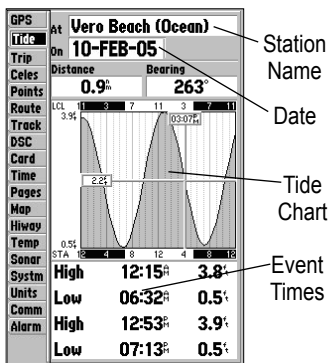

Tide Tab

The top of the page displays the tide station being referenced, below that the date. The top of the chart shows a 24-hour block of local time (LCL) for your location, with the reported station time (STA) appearing at the bottom. Daytime (light bar) and nighttime (dark bar) show across the time scale, with the time progressing from left to right. (Local time scales and sunrise/sunset info may not be available for a few stations). The solid, light vertical lines

are in 4-hour increments, and the light, dotted vertical lines are in 1-hour increments. A solid, vertical line (with the current time box at the top) indicates the time of day when using current date and intersects the tide graph to show their relationship.

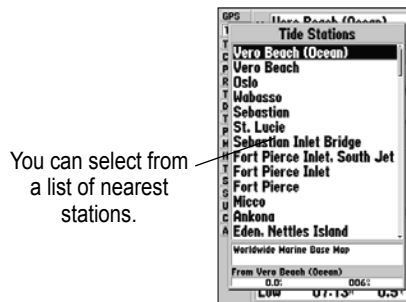

You can select from a list of nearest stations.

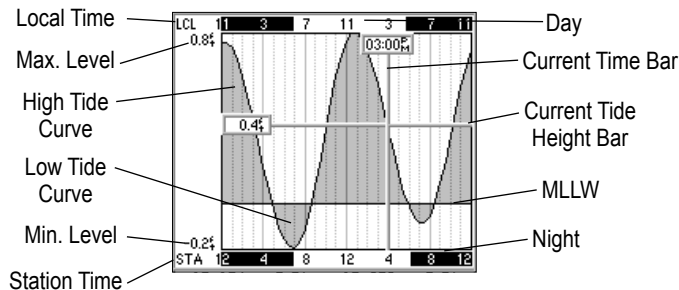

The tide curve shows as a shaded area, where higher tides are taller (blue) and lower tides are shorter (red). The solid, horizontal line (with the current tide box on the left) indicates the current tide height. The figure to the left of the line shows the current tide level in feet. The Mean Lower Low Water (MLLW) appears as a solid, horizontal line near the bottom of the chart (This line only appears if the tide ranges to the zero value or below). The numbers directly below/above LCL and STA indicate the maximum/minimum levels, respectively. The four data fields below the chart, indicate event times and levels the tide changes starting in the upper left field, going downward, then to the upper right and down again.

To select the nearest tide station from you current location:

1. From the **Tide** tab, highlight the **At** field, and press **ENTER**.
2. Highlight a tide station on the list, and press **ENTER** twice.

You can automatically search for the nearest station using a variety of search locations. You must select a location within 100 nm of a tide station. If you are not within this range, you see a message “None Found.” Use the **Nearest To Other** Find option and select a location closer to a tide station.

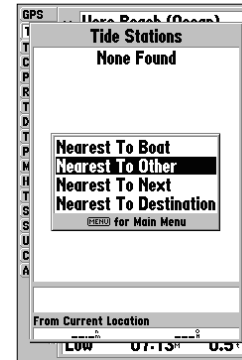

To select a tide station from the map:

1. When the search results appear, press **FIND**, and highlight **Tide Stations**.
2. Press **ENTER**, and then press **MENU**.
3. Highlight **Nearest To Other**, and press **ENTER**.
4. Select a location on the map, and press **ENTER**.
5. A list appears showing the nearest tide stations. Highlight a station, and press **ENTER** twice. If the **None Found** message appears, repeat steps 1-4 until you find a station.

To change the date for the tide chart:

1. Using the **ROCKER**, highlight the **On** field, and press **ENTER**.
2. Enter the date, and press **ENTER**.

To use the current date:

Press **MENU**, highlight **Use Today's Date**, and press **ENTER**.

Move the time bar on the tide chart in 5 minute increments to show tide heights at various times on the chart.

To see tide heights at various times on the chart:

1. Press **MENU**, highlight **Move Cursor**, and press **ENTER**.
2. Press left or right on the **ROCKER** to change the time. Press **QUIT** when finished or press **MENU**, highlight **Stop Moving Cursor**, and press **ENTER**.

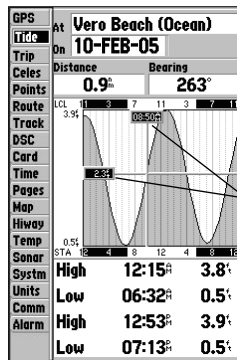

Move the pointer to see tide heights at different times. Tide data shows in a black box when in pointer mode.

Trip Tab

The Trip tab displays the Trip Odometer, Moving Average speed, Total Average speed, Maximum Speed, Stopped Time, Moving Time, Total Time, and Odometer. To reset the data, choose from Reset Trip, Reset Max Speed, Reset Odometer, or Reset All, and press **ENTER**.

GPS	Trip Odometer	Stopped Time
Tide	0.2 ^m	57:18:20
Trips	Moving Average	Moving Time
Celes	0.1 ^m	02:26:14
Points	Total Average	Total Time
Route	0.0 ^m	59:44:34
Track	Maximum Speed	Odometer
DSC	2.0 ^m	0.2 ^m
Card	Reset Trip	
Time	Reset Max Speed	
Pages	Reset Odometer	
Map	Reset All	
Hiway		
Temp		
Sonar		
System		
Units		
Comm		
Alarm		

Celes (Celestial) Tab

The Celestial tab displays celestial data for sun and moon rise/set, moon phase, and approximate sky view location of the sun and moon. The moon phase displays the current visible portion of the moon as a light color. You can display this data for your current location, a location from the map, or a Find item location. Use the current data, or select a different date and time.

Annotations for the Celestial Tab screenshot:

- Position
- Date/Time
- Sun/Moon Event Times
- Moon Phase
- Moon Position
- Sun Position
- Overhead (90°)
- 70°
- 45°
- Horizon (0°)
- Skyview Window

To choose a position:

1. From the **Celes** tab, highlight the **At** field, and press **ENTER**.
2. From the Find list highlight any category, except Other Location, and press **ENTER**. If you want to reference a Find item, select from the Find list, and press **ENTER**.
3. Select an item from the list or tab lists, and press **ENTER**. For a location from the map, choose **Other Location**, press **ENTER**, select a location on the map, and press **ENTER**.
4. From the Find item detail page, highlight **OK**, and press **ENTER**.

The location the unit is using appears in the Date/Time/Position field. The time tables displayed are based on your current time zone. When using a position from another location outside of your time zone, you need to set the Time Zone for that location. See page 63 for more information on setting time zones.

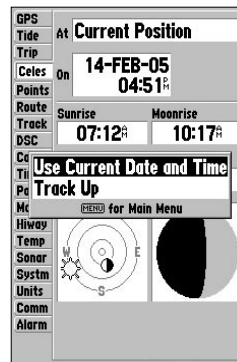
**Celestial Tab Menu****To change the time or date:**

1. From the **Celes** tab, use the **ROCKER** to highlight the date or time, and press **ENTER**.
2. Enter a new date or time, and press **ENTER**.

To use current date and time:

From the **Celes** tab, press **MENU**, use the **ROCKER** to highlight **Use Current Date and Time**, and press **ENTER**.

Points Tab

The Main Menu Points tab features two waypoint sub tabs, User and Proximity, that allow you manage a large number of waypoints quickly and efficiently. The sub tabs also provide a continuously updated proximity waypoint alarm function that can be used to define an alarm circle around items such as submerged hazards or shallow waters.

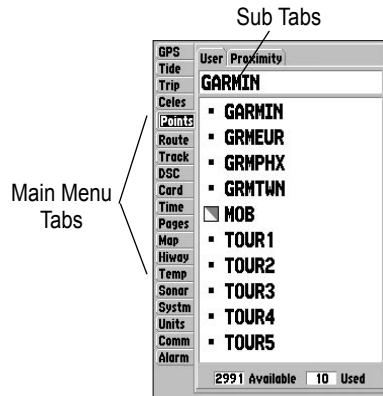

To select the Points (Waypoint) sub tab:

1. Use the **ROCKER** to highlight the **Points** tab. A list of stored waypoints appear to the right of the Main Menu list.
2. Press right one time on the **ROCKER**. The **User** tab is now highlighted.
3. Press down on the **ROCKER** until a waypoint is highlighted.

User Waypoint List

The first waypoint sub tab list available from the Points tab is the User list, which displays a master list of all waypoints currently stored in memory. From the User list, you can review, edit, rename or delete individual waypoints, or delete all user waypoints. The total number of stored and available waypoints is displayed at the bottom of the User Page, with the stored waypoints arranged in numerical/alphabetical order.

The following options are available from the User sub tab of the Points tab:

- **Create Waypoint**—allows you to create a waypoint. (See page 8 for creating a waypoint)
- **Delete Waypoint**—deletes the selected waypoint from the waypoint list and route.
- **Delete By Symbol**—deletes waypoints that uses the same symbol.
- **Delete All**—deletes all waypoints from the unit.



***NOTE:** When a waypoint is deleted from the list, it cannot be recovered from the unit. It is advisable to backup important waypoints to a computer using an optional PC cable and interface software or record them manually.*

To display the waypoint menu options:

Using the **ROCKER**, highlight the **User** tab, and press **MENU**.

To scroll through and review the waypoint list:

1. With the **ROCKER**, highlight the **Points** tab from the Main Menu, and then highlight **User**.
2. Use the **ROCKER** to scroll through the list.
3. Press **ENTER** to review the highlighted waypoint on the **Waypoint Edit** Page.
4. Press **ENTER** to return to the list and automatically highlight the next waypoint.

To search for a waypoint by name:

1. Highlight the name field, and press **ENTER**.
2. Use the **ROCKER** to select the first letter of the name.
3. Move to the right, and enter the second letter, if you do not see the name in the list below.
4. Repeat this until the name appears. Press **ENTER** when you see the name.
5. Highlight the name on the list, and press **ENTER** again to review the waypoint. When finished, highlight **OK**, and press **ENTER**.

To delete an individual waypoint from the list:

1. Use the **ROCKER** to highlight the waypoint to delete, and press **MENU**.
2. Highlight **Delete Waypoint**, and press **ENTER**. You can also highlight the waypoint, press **ENTER**, then highlight **Delete** and press **ENTER**.
3. Select **OK**, and press **ENTER** to confirm the deletion warning.

**To delete waypoints by symbol:**

1. From the **User** sub tab, highlight the waypoint to delete, and press **MENU**. Select **Delete By Symbol**, and press **ENTER**.
2. Use the **ROCKER** to highlight the symbol of the waypoint(s) to delete, and press **ENTER**.
3. Press **ENTER** to confirm. To stop the deletion, choose **Cancel**, or press **QUIT**.

To delete all waypoints or the entire waypoint list:

1. Press **MENU** to select the options window.
2. Use the **ROCKER** to highlight **Delete All**, and press **ENTER**.
3. Highlight **OK**, and press **ENTER** to confirm.

Proximity Waypoint List

The Proximity list allows you to define an alarm circle around a stored waypoint location, and can be used to help you avoid reefs, rocks, or restricted waters. Up to 10 waypoints can be listed, with a maximum alarm radius of 99.99 nautical or statute miles or kilometers. If a proximity alarm circle overlaps with an existing alarm circle, a “Proximity Overlaps Another Proximity Waypoint” message appears. Because the unit only alerts for one of the overlap points, use caution when navigating in these areas. If you enter an alarm circle overlap, you are only alerted to the closest proximity waypoint.

GPS	User: Proximity
Tide	Proximity Alarm
Trip	On
Celes	
Points	Waypoint Distance
Route	GARMIN 12.00 ⁿ
Track	-----
DSC	-----
Card	-----
Time	-----
Pages	-----
Map	-----
Hiway	-----
Temp	-----
Sonar	-----
System	-----
Units	-----
Comm	-----
Alarm	-----

To add a proximity waypoint:

1. Use the **ROCKER** to highlight an empty space on the Proximity list, and press **ENTER**. The Find screen appears. Highlight **Waypoints**, and press **ENTER**.

2. To select a waypoint from the list, use the **ROCKER** to highlight a waypoint from the **User** or **Nearest** tab.

To select a waypoint from the map, highlight either the **User** or **Nearest** tab, and press **MENU**. With **Select From Map** highlighted, press **ENTER**. Use the zoom **In** and **Out** buttons and the **ROCKER** to highlight a waypoint.

3. Press **ENTER** to confirm. The distance field is now highlighted.

4. Press **ENTER** to begin entry of the proximity radius.

5. Use the **ROCKER** to enter a distance value (to 99.99 units), and press **ENTER**.

Proximity Waypoint

Proximity Circle

A dashed circle appears showing the alert boundary for the proximity waypoints.

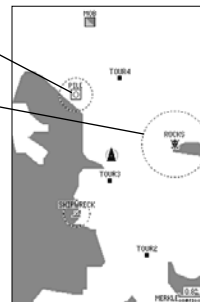

To turn on or off proximity alarms:

1. Use the **ROCKER** to highlight the field below **Proximity Alarm**, and press **ENTER**.
2. Select the **ON** or **OFF** setting, and press **ENTER**.

To display the waypoint menu options:

Using the **ROCKER**, highlight the **Proximity** tab, and press **MENU**.

To clear one or all proximity waypoint(s) from the list:

1. Use the **ROCKER** to highlight the proximity waypoint, and press **MENU**.
2. To clear a single alarm, highlight **Delete Alarm**, and press **ENTER**.
3. To clear all proximity waypoints, select the **Delete All** option, and press **ENTER**.
4. Use the **ROCKER** to highlight **OK**, and press **ENTER**.

The following options are available from the Proximity sub tab of the Points tab:

- **Delete Alarm**—removes selected waypoint from proximity list.
- **Delete All**—removes all waypoints from proximity list.

Routes Tab

The Route List Page displays all the routes currently stored in memory, along with a descriptive name for each route. When a route has been created, it can be activated and used for navigation with the **NAV** key. A route can be followed in the same sequence as it was originally created, or you can invert the route and navigate from the end waypoint back to the beginning waypoint. From the Route list menu, you can choose New Route (page 17), Copy Route, Delete Route, or Delete All.

To start a route with the NAV key:

1. From any page, press **NAV**, using the **ROCKER**, highlight **Follow Route**, and press **ENTER**. If you highlight a route from the **Route List** or **Route Review** Page, and press **NAV**. The window automatically shows **Follow <the route name>**.
2. Highlight the route you want to navigate, and press **ENTER**.
3. Choose **Activate** or **Invert and Activate**, and press **ENTER**. **Activate** uses the route as is. **Invert and Activate** reverses and starts the route.

If you highlight a route name from the Route List and press **NAV**, the name automatically appears.



To stop navigation of a route:

Press **NAV**, highlight **Stop Navigation**, and press **ENTER**.

To copy or delete a route:

1. From the **Route List**, highlight the route you want to copy or delete using the **ROCKER**, and press **MENU**.
2. Choose either **Copy Route** or **Delete Route** and press **ENTER**. With **OK** highlighted, press **ENTER** again to confirm a deletion. Copy uses the same route name with an additional number, starting at 1, at the end of the route name.

To delete all routes:

1. From the **Route List**, press **MENU**.
2. Highlight **Delete All** and press **ENTER**. With **OK** highlighted, press **ENTER** again to confirm the deletion.

Route Review Page

After you create a route, use the Route Review Page to review and modify the route displayed.

To show the Route Review Page:

1. Press **MENU** twice, highlight the **Route** tab.
2. Highlight the route you want to review, and press **ENTER**.

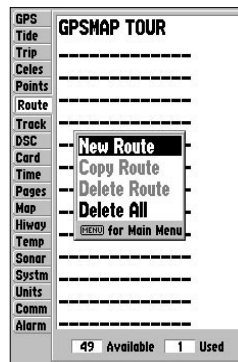

Route List Menu

Route Review Menu Options

Menu options available from the Route Review Page are Edit on Map, Add Before, Remove, and Trip Planning.

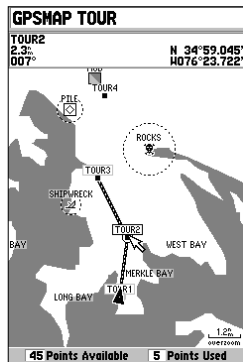

Highlight a point, and press **ENTER** to review it.

Edit on Map—allows you to review and modify the route displayed for each point (waypoint or map item) on a map page. Use the pointer to insert a new route point on a route leg, review the waypoint, or map item.

To edit the route on the map:

From the Route Review Page, press **MENU**, highlight **Edit on Map**, and press **ENTER**.

To edit a route point:

Use the **ROCKER** to highlight a route waypoint, and press **MENU**.

To review a route point:

Highlight the point, and press **ENTER**. Press **ENTER** again when finished.

A pop-up menu of editing choices appear, with options for removing, moving (user waypoints only), or adding turns to the beginning or end of the route.

To remove a route waypoint:

Highlight the **Remove** option, and press **ENTER**.

To move a route waypoint:

1. Highlight the **Move** option, and press **ENTER**.
2. Move the pointer to the new map location, and press **ENTER**.

To add turns at the beginning or end of the route:

1. Select the first (to add waypoints to the beginning of the route) or last (to add waypoints to the end of the route) route waypoint with the map pointer, and press **MENU**.
2. Highlight the **Add** option and press **ENTER**.
3. Move the pointer to the new point or location, and press **ENTER**.
4. If you are not inserting an existing waypoint, press **ENTER** to confirm the new waypoint.
5. Repeat steps 3 and 4 to insert additional waypoints, or press **QUIT** to finish.

The GPSMAP 182/182C's route edit mode also allows you to insert a new route waypoint in any route leg using the map pointer.

To insert a new waypoint between two existing route waypoints:

1. Use the **ROCKER** to select the leg you want to insert the new waypoint in (the route line is now highlighted and a dotted line appears when the leg is selected), and press **ENTER**.
2. Move the pointer to the new map location, existing waypoint, or map item (**ADD** is displayed below the arrow and the route lines move with the arrow), and press **ENTER**.
3. If you are not inserting an existing point, press **ENTER** to confirm the new waypoint.

Add Before—inserts a waypoint into the list of route points or add a point(s) onto the end of the route.

To insert a point into the route, or add a point to the end:

1. From either the Route Review or Active Route Pages, use the **ROCKER** to highlight the point you want to insert the new point before (to add a point to the end, highlight the blank field at the bottom of the list), and press **MENU**.
2. Highlight **Add Before**, and press **ENTER**.
3. From the **Find** menu, highlight **Waypoints**, and press **ENTER**. (You can also choose from other points, such as Cities or Tide Stations from this list.) From either the **User** or **Nearest From Current Location** tab lists, choose the waypoint you want and press **ENTER** twice. (See page 50 for searching for waypoints by name.)

Or

To select a waypoint from the map, highlight the **User** or **Nearest** tab, and press **MENU**. With **Select From Map** highlighted, press **ENTER**. Use the zoom **IN** and **OUT** keys and the **ROCKER** to highlight a waypoint on the map, and press **ENTER**.

Drag the route leg to an existing waypoint (shown), map item, or a blank spot on the map to create a new route point.

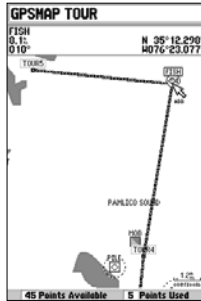

Remove—removes a point (waypoint or map item) from a route. This option is available from both the Route Review and Active Route Pages.

To remove a point from a route:

1. From either the Route Review or Active Route Pages, use the **ROCKER** to highlight the point to remove, and press **MENU**.
2. Highlight **Remove**, and press **ENTER**.

Trip Planning—the Route Review and Active Route Pages also display trip-planning information for each leg or the entire route. Available information includes Course, ETA, Fuel (to point), Leg Distance, Leg Fuel, Leg Time, Sunrise and Sunset (at point location), and Time To (point).

To use the Trip Planning feature:

1. To select a planning field, highlight a route from the Route List, and press **ENTER** to display the Route Review Page.
2. One of nine available planning fields appears to the right of each route waypoint and its distance. Press left or right on the **ROCKER** to select an item.
3. To enter planning information, from the Route Review Page only, press **MENU**, and select **Trip Planning** from the options list. Enter the figures for Speed, Fuel Flow, Departure Time, and Departure Date. Press **QUIT** to return to the Route Plan Page.

Saved Sub Tab

The Saved sub tab displays and manages a list of any saved track logs, allows for TracBack activation, and map display of saved logs. The active log stores up to approximately 2,500 track log points, based on the criteria specified in the Track settings. Up to 15 track logs can be saved in memory, with up to 500 track log points in each saved log. A TracBack can be activated from any of the saved tracks on this tab.

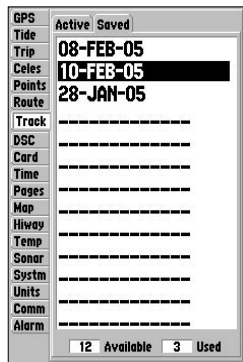

Saved Sub Tab

For the Active sub tab, the following settings are available:

Record Mode—contains three track recording options:

- **Off**—the track log is not recorded. Selecting the off setting prevents you from using the TracBack feature.
- **Fill**—a track log is recorded until the track memory is full.
- **Wrap**—records the track log continuously. After the available memory is full, the oldest track data is replaced with the newest track data.

Interval—defines the frequency the track plots are recorded. Three interval settings are available:

- **Distance**—records track based on a user-defined distance between points.
- **Time**—records track plot based on a user-defined time interval.
- **Resolution**—records track plot based on a user-defined variance from your course over ground. The resolution option is the default setting and is recommended for the most efficient use of memory and TracBack performance. The distance value (entered in the value field) is the maximum error allowed from the true course before recording a track point.

- **Value**—defines the distance or time used to record the track log.
- **Save**—saves the current active track log.
- **Erase**—clears the active track log stored in memory.

For the Saved sub tab, the following menu options are available:

- **Review On Map**—displays the saved track log on a Track Map Page.
- **Delete Track**—deletes the highlighted saved track log from memory.
- **Delete All**—deletes all saved track logs from memory.

You can use the Review On Map option to display a saved track on a Track Map Page.

To activate a TracBack from the Saved tab list:

1. Using the **ROCKER**, highlight a track, and press **NAV**.
2. The **Follow <track name>** automatically appears highlighted. Press **ENTER**.
3. Choose either **Original**, which navigates you from the end to the start of your trip, or **Reverse**, which navigates you from the start to the end of your trip, and press **ENTER**.

The track name automatically appears when highlighted on the Saved list and **NAV** is pressed.

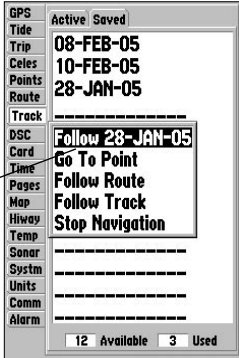

DSC Tab

Digital Selective Calling (DSC) uses marine VHF radio and Global Positioning System (GPS) technologies to transmit and receive location information. DSC is used by mariners to assist them in two major areas: Distress Calls and Position Reporting. See page 22 and the “Appendix” for more information on DSC and using it with your GPSMAP 182/182C.



Card Tab

The Card tab contains options for saving waypoints, routes and tracks to a data card. When data is saved to a data card, it can be exchanged with other compatible units and Garmin’s MapSource PC program.

To transfer data to/from a data card:

1. Insert the data card. From the **Card** tab, select the check box next to each type of item you want to transfer.
2. Highlight **Save To Card**, and press **ENTER** to save the selected items to the data card.
3. If transferring data from the card to the unit, highlight **Merge From Card**, and press **ENTER** to combine the selected items with those of your GPS. Highlight **Replace From Card**, and press **ENTER** to overwrite all selected items on your GPS.
4. A **Transfer Complete** message appears after the data is transferred. Press **QUIT**.

Time Tab

The time tab displays the current time and date, allows you to adjust the 12 or 24 hour time format, enter a time zone, and adjust for daylight saving time.

The following options are available:

- **Time Format**—choose from 12 or 24 hour (military) time format.
- **Time Zone**—choose your correct time zone to show correct local time or enter a UTC Offset. The UTC (also called Greenwich Time) offset is how many hours you are ahead or behind the time line.
- **Daylight Savings Time**—choose from Auto, On, or Off to adjust for daylight saving time.

Pages Tab

The Pages tab allows you to turn on or off any of the main pages or Jump To a particular page. You can also set the page that appears first when you turn on the unit or enable/disable the GPS Info on the initial screen.

To select or deselect a main page:

1. Use the **ROCKER** to highlight the box to the left of the page name.
2. Press **ENTER** to selects or deselects that page. When a page is selected a check mark appears in the box. You must leave at least one page selected.

To set the first page:

1. Use the **ROCKER** to highlight the **First page** option, and press **ENTER**.
2. Highlight the page you want to appear first, and press **ENTER**.

You can also press **Menu**, choose from one of the following, and press **ENTER**:

- **All Pages**—selects all pages.
- **Chartplotter Only**—selects the Map Page only.
- **Nav Tools Only**—selects the Pointer, Numbers, Highway, and Active Route Pages only.
- **Basic Fishfinder**—selects the Garmin Sonar Page only if equipped with an external Sonar Module.
- **Defaults**—selects all pages.

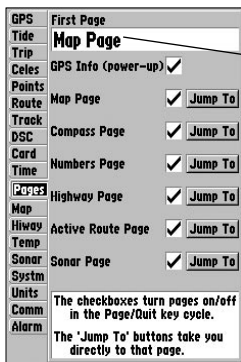

Pages Tab

Map Tab

The Map tab changes the display properties of the Map Page. The following pages contain descriptions of the Map tab's eight sub tabs.

General Sub Tab

General	Source	Waypoints	Points
Detail		Normal	
Orientation		North Up	
AutoZoom		Off	

- **Detail**—Most, More, Normal, Less, Least: controls how much map detail appears. This setting only applies to map features set to Auto. Features that have a specified scale or are turned off are unaffected by this setting.
- **Orientation**—North Up: fixes the top of the map display to a north heading. Track Up: fixes the top of the map display to the current track heading. Course Up: fixes the map so the direction of navigation is always up.

- **AutoZoom**—On, Off: when on, the map automatically adjusts the map scale to a lower scale as you approach your destination point.
- **Color Mode**—Water Mode, Land Mode: lightens the shade of the water areas in Water Mode and land in Land Mode. This option is only available on the GPSMAP 182.

Source Sub Tab

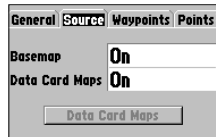

- **Basemap**—On/Off: turns on or off the built-in basemap.
- **Data Card Maps**—On/Off: turns on or off all BlueChart or MapSource data loaded in the unit or on the data card.
- **Built-in Maps**—On/Off: turns on or off all built-in BlueChart maps.

To display the Map Information Page:

1. Highlight the **Detail** option box, and press **ENTER**.
2. Use the **ROCKER** to scroll through the list of maps.
3. To select or deselect a map, highlight the check box to the left of the name of a map.
4. Press **ENTER** to select/deselect the map. The map is selected and appears on the Map Page when a check mark appears in the box adjacent to that map.
5. To display detailed information and notes for each area, highlight a name and press **ENTER**. To view the notes for that area, choose **Show Notes**. To scroll through the notes, highlight the notes, press **ENTER**, and use the **ROCKER** to scroll up, down, left, and right, or press **MENU** and choose a scroll option.



Waypoints Sub Tab

General	Source	Waypoints	Points L:
		Text	Zoom
Waypoints		Med	Auto
Active Route		Med	Auto

The Waypoints and Active Route options each contain adjustments for Text and Zoom.

- **Text**—None, Small, Medium, and Large: controls the screen size of the name.
- **Zoom**—Auto, Off, 120 ft-800 mi: sets the maximum scale features should appear on the Map Page. Some types of data only show up at specific zoom scales.

Points Sub Tab

Waypoints	Points	Nav aids	Nav L:
		Text	Zoom
Spot Soundings		Small	On
Tide Stations		None	Auto
Services		None	Auto

The Spot Soundings, Tide Stations, and Services options each contain adjustments for Text and Zoom.

- **Text**—None (except Spot Snd.), Small, Medium, and Large: controls the screen size of the name.
- **Zoom**—Auto, Off, 120 ft-800 mi: sets the maximum scale features should appear on the Map Page. Some types of data only show up at specific zoom scales.

Nav aids Sub Tab

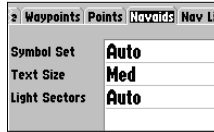

- **Symbol Set**—Auto, Garmin, NOAA, International: controls the navaid symbol set.
- **Text Size**—Small, Medium, and Large: controls the screen size of the name.
- **Light Sectors**—Off, Auto, On: controls the drawing light sectors on the map.

Nav Line Sub Tab

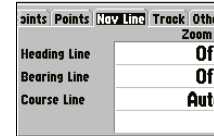

- **Heading Line**—On/Off: draws an extension from the end of the boat icon in the direction of travel.
- **Bearing Line**—On/Off: toggles the black/white line that points to the current navigation point.
- **Course Line**—Auto, Off, 120 ft-800 mi: sets the maximum zoom scale that the course line appears on the screen.

Track Sub Tab

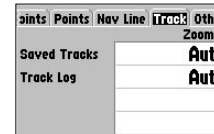

The Saved Tracks and Track Log options each contain adjustments for Zoom.

- **Zoom**—Auto, Off, 120 ft-800 mi: sets the maximum scale the feature should appear on the Map Page. Some types of data only show up to specific zoom scales.

Other Sub Tab

Is	Nav aids	Nav Line	Track	Other
			Text	Zoom
Accuracy Circle				On
Lat/Lon Grid		Med		Off
Map Outlines				On

- **Accuracy Circle**—On/Off: toggles the circle on and off. The circle represents the approximate accuracy of the unit based on EPE, DOP, and basemap quality. Your location is within the circle.
- **Lat/Lon Grid**—Text—None, Small, Medium, and Large: controls the screen size of the name. Zoom—Auto, Off, 120 ft-800 mi: sets the maximum scale the feature should appear.
- **Map Outlines**—On/Off: toggles the coverage boxes for BlueChart/MapSource data on and off.

Hiway (Highway) Tab

The Highway tab contains display settings for the Highway Page. Refer to the “Highway Page” section on page 35.

Temp (Temperature) Tab

The Temperature tab displays the water temperature log. The temperature log requires input from a temperature transducer/sensor. The most recent temperature measured displays on the far right side of the chart with the history trailing to the left. The dotted lines within the chart indicate intervals in the temperature scale and the duration of time.

The following settings are available:

- **Temperature Scale**—controls the temperature range for displaying the log. Select Auto to have the unit automatically determine the best range, or select a span of 2, 4, 6, 8, or 10 degrees.
- **Time Duration**—controls the number of temperature readings displayed on the log. Shorter time durations display a greater the number of log points. Use longer time durations to detect temperature trends, instead of immediate readings.

Sonar Tab

The Sonar tab contains setup options for the Sonar Page. The Sonar Page is not active if you do not have an external Sonar Module with transducer. Refer to the “Using Sonar” section on pages 78-91 for more information on sonar setup options.

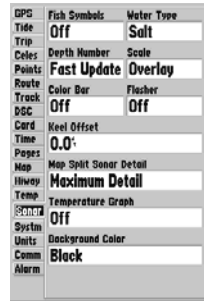

System (System) Tab

The System tab controls system setting for beeper, speed filter, languages, system mode, and simulator controls, restores factory settings, displays the software version, and prepares software update cards.

The following settings are available:

- **Beeper**—Off, Alarms Only, Key and Alarm: controls audible beeps for keys and alarms.
- **Speed Filter**—Off, Auto, On: averages speed-readings.
- **Language**—displays the on-screen display languages.
- **System Mode**—sets Normal or Simulator Mode.
- **Set Position***—sets your location while in Simulator Mode. See page 3 for additional instructions.
- **Track Control***—Auto Track, User Track: controls your heading in Simulator Mode.
- **Track***—sets your heading in Simulator Mode.
- **Speed***—sets your speed in Simulator Mode.
- **Transducer***—sets a transducer type.

* These fields are only available when the unit is in Simulator Mode.

The following option is also available from the System tab:

- **System Information**—displays the unit’s software, basemap version, and electronic serial number.

Press **MENU** to access the following options:

- **Defaults**—restores settings on System Page to default values.
- **All Unit Defaults**—restores all settings to Garmin’s original setup values for the entire unit.



Units Tab

The Unit tab defines the Position Format, Map Datum, Heading, Distance, Speed, Elevation, Depth, and Temperature units.

The following settings are available:

- **Position Format**—changes the coordinate system. You should only change the position format if you are using a map or chart that specifies a different position format or want to use a format with which you are familiar.

For additional information on Lorán TD setup, see page 108.



NOTE: *The Units tab settings affects how navigation information is displayed on the GPSMAP 182/182C. When in doubt, seek assistance.*

If you are using a map or chart in conjunction with your GPS, make sure the settings under the Units tab of the GPSMAP 182/182C match that of the map or chart. This information should be displayed somewhere on the map or chart. If the information is not present, contact the map or chart maker to determine what position format, datum, heading and units of measure are being used for the map or chart.

- **Map Datum**—sets the datum reference used to determine a given location. The default setting is WGS 84. The unit automatically chooses the best datum depending on your chosen position format. Datums are used to describe geographic locations for surveying, mapping, and navigation. You should only change the datum if you are using a map or chart that specifies a different datum.



WARNING: *Selecting the wrong map datum can result in substantial position errors. Unless otherwise specified by the navigation documentation you are using, use the default WGS 84 datum for best overall performance.*

GPS	Position Format
Tide	hddd°mm.mmm'
Trip	
Celes	Map Datum
Points	WGS 84
Route	Heading
Track	Auto Mag Var 003°E
DSC	
Card	Distance, Speed and Elevation
Time	Nautical (nm, kt, ft)
Pages	
Map	Depth
Hirway	Feet (ft)
Temp	Temperature
Sonar	Fahrenheit (°F)
System	
Units	
Comm	
Alarm	

- **Heading**—selects the reference used in calculating heading information. You can select from Auto Mag Var, True, Grid, and User Mag Var. Auto Mag Var provides magnetic north heading references that are automatically determined from your current location. True provides headings based on a true north reference. Grid provides headings based on a grid north reference (and is used in conjunction with the grid position formats described on page 70). User Mag Var allows you to specify the magnetic variation at your current location and provides magnetic north heading references based upon the variation you enter.

To enter a user defined magnetic variation:

1. With the **Heading** field set to **User Mag Var**, highlight the heading reference field (immediately to the right), and press **ENTER**.
2. Use the **ROCKER** to enter the magnetic variation at your current location, and press **ENTER**.



WARNING: *If User Mag Var is selected, you must periodically update the magnetic variation as your location changes. Using this setting, the unit does not automatically calculate and update the magnetic variation at your present location. Failure to update this setting can result in substantial differences between the information displayed on your unit and external references, such as a magnetic compass.*

GPS	Position Format
Tide	hddd°mm.mmm'
Trip	
Celes	Map Datum
Points	WGS 84
Route	Headings
Track	User Mag Var 010E
DSC	Distance, Speed and Elevation
Card	
Time	Nautical (nm, kt, ft)
Pages	Depth
Map	Feet (ft)
Hwyay	
Temp	Temperature
Sonar	Fahrenheit (°F)
Systm	
Units	
Comm	
Alarm	

Manually enter a magnetic variation.

- **Distance, Speed and Elevation**—select the units of measure for distance, speed, and elevation readouts in nautical (nm, kt, m), statute (mi, mh, ft), or metric (km, kh, m) terms.
- **Depth**—select units of measurement for depth in feet (ft), fathoms (fa), or meters (m).
- **Temperature**—select the units of measure for temperature in Fahrenheit (°F) or Celsius (°C).

Comm (Communications) Tab

The Communications tab controls the input/output format used when connecting your GPSMAP 182/182C to external NMEA devices, such as an external Sonar Module, a DGPS beacon receiver, a personal computer, or another Garmin unit.



***NOTE:** If a DGPS receiver is used, WAAS capability is automatically turned to off. See pages 98 and 99 for wiring and NMEA version information.*

The unit supports two input/output ports.

Port 1

- **Garmin Data Transfer**—is the proprietary format used to upload/download MapSource data, exchange waypoint, route, track, almanac, and proximity data with a PC or another Garmin unit. When you select Garmin Data Transfer, there are 11 Transfer Modes to choose from: Host, Request Almanac, Request Proximity, Request Routes, Request Tracks, Request Waypoints, Send Almanac, Send Proximity, Send Routes, Send Tracks, and Send Waypoints.
- **Garmin Remote Sonar**—supports a Garmin external Sonar Module interface.

- **NMEA In/NMEA Out**—supports the input/output of standard NMEA 0183 data, and sonar NMEA input support for the DBT, DPT, MTW, and VHW sentences.
- **None**—provides no interfacing capabilities.

Port 2

- **Garmin Remote Sonar**—supports a Garmin external Sonar Module interface.
- **Garmin DGPS**—supports connections with a Garmin DGPS beacon receiver.
- **Other DGPS**—supports DGPS input using a standard RTCM format, without any output capabilities.
- **NMEA In/NMEA Out**—supports the input/output of standard NMEA 0183 data, and sonar NMEA input support for the DPT, MTW and VHW sentences. You can also adjust the NMEA output.
- **RTCM In/NMEA Out**—supports Differential GPS (DGPS) input using a standard RTCM format and also provides NMEA 0183 output.
- **None**—provides no interfacing capabilities.

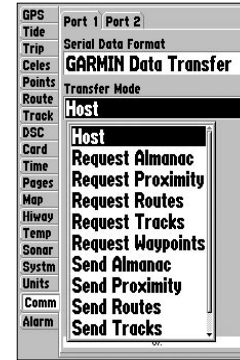

When transferring data between two Garmin units, always set one to Host and use the other unit to either Send or Request data.

To select an input/output format:

1. Select the **Port** tab, highlight the **Serial Data Format** field, and press **ENTER**.
2. Use the **ROCKER** to select the setting, and press **ENTER**.

To select a transfer mode:

1. Use the **ROCKER** to select **Garmin Data Transfer** in the **Serial Data Format** field.
2. Highlight the **Transfer Mode** field, and press **ENTER**.
3. Use the **ROCKER** to select the setting, and press **ENTER**.

Advanced NMEA settings to adjust the NMEA output are available if you have one of the ports set to NMEA In/NMEA. Advanced NMEA settings enable/disable certain sentences and adjust the number of Lat/Lon output precision digits. Settings affects both Port 1 and Port 2 NMEA outputs.

To adjust the NMEA output:

1. From the **Comm** tab, press **MENU**, highlight **NMEA Setup**, and press **ENTER**.
2. Highlight an option, and press **ENTER**.
3. Use the **ROCKER** to select the setting, and press **ENTER**. Press **QUIT** to return to the **Comm** tab.

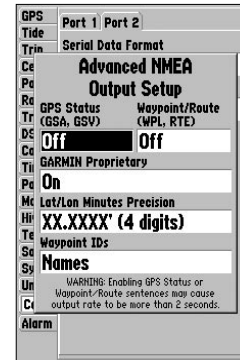

Advanced NMEA Output Setup Page

To restore the Serial Data Format settings back to the default Garmin Data Transfer:

From the **Comm** tab, press **MENU**, highlight **Defaults**, and press **ENTER**.

If **Garmin DGPS** or **RTCM In/NMEA Out** format is selected, additional fields are provided to control a Garmin differential beacon receiver directly from your GPSMAP 182/182C. The unit can automatically scan for the DGPS beacon signal, or you can enter the beacon frequency and bit rate on the unit and the information is used to tune the beacon receiver.

To have the unit automatically scan for a frequency:

1. With the unit set to **Garmin DGPS** or **RTCM In/NMEA Out**, use the **ROCKER** to highlight the **Beacon** field, and press **ENTER**.
2. Highlight **Scan**, and press **ENTER**. The numbers in the **Frequency** field change as the unit scans from 284 kHz to 325 kHz, 200 bit rate, then 100 at 6-second intervals.

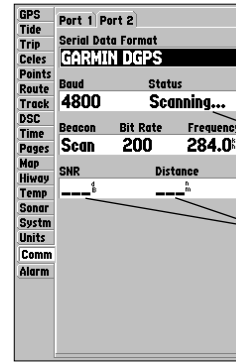

Status Field

SNR and Distance shows data when signal is received.



NOTE: The DGPS beacon transmitters are operated by the U.S. Coast Guard (or similar government agency in other countries), and are responsible for their accuracy and maintenance. For DGPS transmitter problems or to find the most updated list of frequencies and coverage areas, contact your local USCG, or see their Web site at <http://www.uscg.mil/>.

To restart the scan:

Press **MENU**, highlight **Restart Scan**, and press **ENTER**.

To manually enter a frequency and bit rate:

1. With the unit set to **Garmin DGPS** or **RTCM In/NMEA Out**, use the **ROCKER** to highlight the **Beacon** field, and press **ENTER**.
2. Highlight **User**, and press **ENTER**.
3. Highlight the **Frequency** or **Bit Rate** field, press **ENTER**, enter a frequency or bit rate, and press **ENTER** when finished.

The Status field shows one of the following:

- **Tuning**—the unit is attempting to tune to the specified frequency and bit rate.
- **Scanning**—the unit is automatically scanning through the frequencies and bit rates.
- **Receiving**—the unit is receiving DGPS signal and ready for operation.
- **Check Wiring**—the unit is not making connection with DGPS receiver.

When the unit is receiving a DGPS signal, the SNR (Signal to Noise Ratio), and Distance fields show data. The SNR range is 0dB to 30dB, with 30 being the best. The Distance field is based on the signal broadcast from the DGPS site.

Alarm Tab

The Alarm tab allows you to define the alarm settings. The Alarm tab is divided into three sub tabs: System alarms, Nav alarms, and Sonar alarms.

System Sub Tab

- **Clock**—provides an alarm for the system clock. Enter a time in the time field, and turn the alarm on and off from the control field menu. Remember to enter alarm times in the same time format (UTC or local) you are using for your system. The unit must be on for the clock alarm to work.
- **Battery**—sets an alarm to sound when the battery is reaching a critical state of discharge.
- **DGPS and Accuracy**—DGPS alarm sounds when the unit loses a differential fix. The accuracy alarm sounds when the GPS position accuracy falls outside the user-set value.

Nav Sub Tab

- **Anchor Drag**—sets an alarm to sound when you have exceeded a specified drift distance. Enter a value in the distance field, and use the control field to turn the alarm on and off.

- **Arrival**—sets an alarm to sound when at specified distance or time away from a destination waypoint. Enter a distance radius or time for sounding the alarm and use the control field to set the alarm to **Off**, **Dist** (Distance), or **Time**.
- **Off Course**—sets an alarm to sound when you are off course by a specified distance. Enter a distance in the distance field and use the control field to turn the off course alarm on and off.

Sonar Sub Tab

You must be receiving sonar NMEA data for these functions to work. See “Using Sonar” pages 78-91 for more information.

- **Shallow Water/Deep Water**—set alarms to sound when you enter an area of specified depth that is too shallow or too deep. Enter a depth in the distance fields and use the control fields to turn the alarms on and off.
- **Water Temperature**—sets an alarm to sound when the transducer reports a temperature either above, below, inside, or outside the specified values.
- **Fish**—sets alarm to sound when unit detects a fish of the specified symbol size.

To set an alarm:

1. Use the **ROCKER** to highlight a sub tab.
2. Highlight the field you want, and press **ENTER**.
3. Change the mode to the setting, and press **ENTER**.
4. Highlight the next field to the right, press **ENTER**, enter the settings, and press **ENTER** to finish.
5. If you want the alarm to display and beep until acknowledged, highlight the **Persist** box, and press **ENTER**.

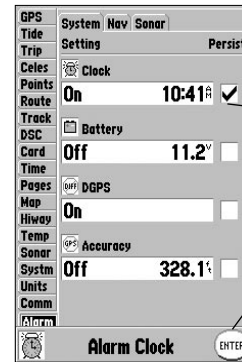

If **Persist** is checked, an alarm stays active until acknowledged.

Press **ENTER** to acknowledge an alarm.

USING SONAR

This section covers the additional sonar options for the GPSMAP 182/182C when used in conjunction with a Sounder Module. Read the *Installation Instructions* to properly install the Sounder Module.



NOTE: You **MUST** have a Sounder Module installed and connected to your GPSMAP 182/182C to use the sonar features.

When a Sonar Module, such as the GSD 20, and a transducer are connected to the GPSMAP 182/182C, the Sonar Page is added to the page sequence. To view the Sonar Page, press **PAGE** or **QUIT** repeatedly until it appears.

Sonar Page

The Sonar Page is where your GPSMAP 182/182C Sounder becomes a powerful fishfinder/flasher. Fish appear as colored arches or as fish icons. Both fish icons and arches appear in three different sizes. Thermoclines are shown as shades of blue. The area of strongest sonar return is displayed as solid white (if Whiteline is active). Typically, the bottom is the primary whiteline. A thin whiteline indicates a soft bottom and a thick whiteline follows the contour of the bottom and show any objects of reasonable size.

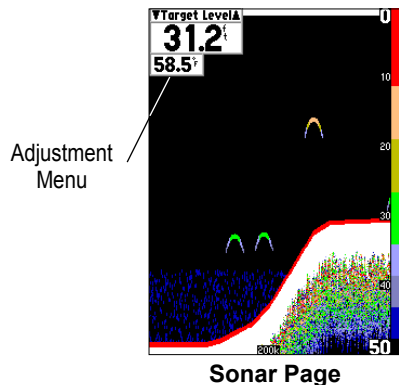

Using the Adjustment Menu

The Adjustment window gives you direct access to the settings and features most commonly used on the Sonar Page. The option selected currently appears in the upper left of the display.

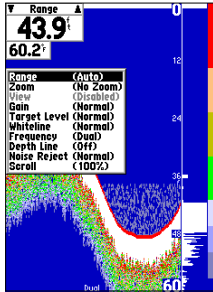

Press **MENU** and highlight **Adjustments** to see a list of all options and their current settings.

To select an adjustment option from the Sonar Page:

1. Press the **ROCKER** left/right to scroll through the options in the upper left of the display.
2. Press **ENTER** to access the option's adjustment window.

Or

1. Press **MENU**, highlight **Adjustments**, and press **ENTER**. A list of all options and their current settings appears, with the selected option highlighted.

2. Press up or down on the **ROCKER** to select the option, and press **ENTER** to access the adjustment window.
3. To exit any of the adjustment options, press **QUIT**.

To change an Adjustment Menu setting:

1. Select an adjustment option to change using one of the two methods described previously. The adjustment window automatically times out and disappears when the unit is idle for 20 seconds.
2. Press the **ROCKER** up or down to place the pointer or setting bar at the setting, range, or percentage (off, 1-100%).
3. Press **ENTER** or **QUIT** to exit the adjustment window, or press left or right on the **ROCKER** to view another adjustment window.

To change a setting back to Normal or Auto:

1. While on the adjustment window for the option, press **MENU**.
2. Select the setting, and press **ENTER**.

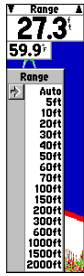

Range Adjustment

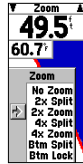

Zoom Adjustment

Range—sets the display depth range used for viewing. The unit can be set to automatically track the bottom or set to a user-specified depth range. Auto Mode displays the most information possible while continuously showing the bottom.

Zoom—used to quickly select a display zoom scale or split the display. When a scale other than **No Zoom** is selected, the Adjustment Menu displays a new selection labeled **View**. The Zoom setting is divided into six display levels:

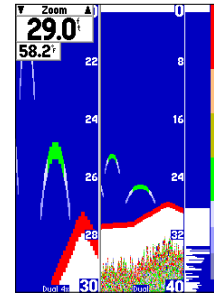

4X Split Zoom Display (Dual Frequency Mode)

- **2X Split**—shows two reduced-size sonar pictures at the same time. The right half of the display screen shows the complete sonar picture at its original scale. The left half shows a portion of the original picture at 1/2 depth scale.
- **2X Zoom**—displays the 2X zoomed picture on the full screen and does not show the original depth scale.
- **4X Split**—shows two reduced pictures; the right at the original depth scale and the left at 1/4 the original depth scale.
- **4X Zoom**—displays only the 4X zoomed picture on the full screen. However, if Dual Frequency Display is set to Split, then a 50/200kHz split screen appears.

- **Btm (Bottom) Split**—shows two reduced pictures; the right at the original depth scale and the left showing sonar returns from the bottom up. All target depths read as a distance from the bottom.
- **Btm (Bottom) Lock**—displays only the Bottom Lock picture (returns from the bottom up) on the full screen. However, if Dual Frequency Display is set to Split, then a 50/200kHz split screen appears.

When selected, the zoomed picture becomes the Sonar Page display. Cycle through the sonar zoom display levels by pressing the **IN** or **OUT** keys. The Zoom function can be deselected by pressing the **OUT** key until the No Zoom setting appears.

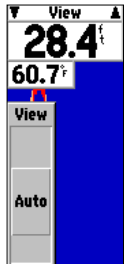

View Adjustment

View/Span—available when a Zoom scale other than No Zoom is selected. The View or Span setting is used to change the viewing range of a zoomed display. If the Zoom is set to 2X split or 4X split, only the zoomed portion on the left side of the screen is affected by the change. If the Zoom is set to Bottom Split or Bottom Lock, Span adjusts how far off the bottom the unit displays data. In Zoom mode, you can control the view of the left side of the split.



Gain Adjustment

Gain—controls the sensitivity of the unit’s receiver. This provides some flexibility in what is seen on the display. To see more detail, increase the receiver sensitivity by selecting a higher gain percentage. If there is too much detail or if the screen is cluttered, lowering the sensitivity can increase the clarity of the display.

Target Level—adjusts how dark or light a return (or target) is displayed on-screen. A Color Bar (see page 86) appears on the right side of the screen as you adjust this setting. The higher the percentage, the darker the return appears. This setting does not increase or decrease the unit gain.

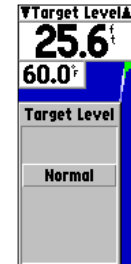

Target Level Selection

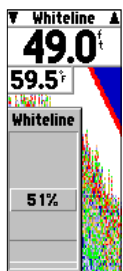

Whiteline Adjustment

Whiteline—controls how the unit displays information about the bottom type (hard or soft). With the Whiteline off, the bottom return displays as red and contains no information on bottom hardness. With Whiteline set at Normal or 1-100%, the bottom return becomes white with a red line indicating where the water meets the bottom. To turn the Whiteline off, press the **ROCKER** down until the setting bar is all the way at the bottom of the range and reads off. See page 91 for more detail on this feature.

Frequency—allows you to choose a transducer frequency. Frequency refers to the pitch of the sound that the transducer sends and receives. Choose between 200kHz, 50kHz, or Dual frequency.

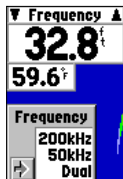

Frequency Adjustment

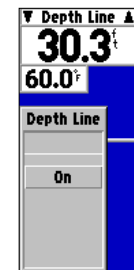

Depth Line Adjustment

Depth Line—adds a horizontal depth line across the display that is used to measure the depth of underwater objects. The depth of the line appears in a box on the right side of the line. Press up or down on the **ROCKER** to control the position of the line on the graph. The depth is displayed in a window on the right side of the line. To turn the Depth Line off, press the **ROCKER** up until the setting bar is all the way at the top of the range and reads off.

Noise Reject—helps filter unwanted noise from the graph. The Noise Reject tool can be turned off, set to Normal (automatically adjusts for optimum viewing), or to a fixed 1-100% setting. When setting the Noise Reject tool, the **HIGHER** the noise rejection setting, the less likely the unit is to **NOT** show fish or structure. To turn the Noise Reject off, press the **ROCKER** down until the setting bar is all the way at the bottom of the range and reads off.

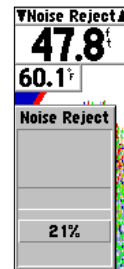

Noise Reject Adjustment

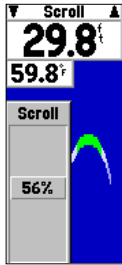

Scroll Adjustment

Scroll—adjusts the rate that the graph scrolls from right to left. If you are sitting still or the graph is moving too fast, slowing the scroll rate or pausing it can be beneficial.

Sonar Page Options

The GPSMAP 182/182C's Sonar Page features a menu page that provides access to additional functions and to layout and data field options.

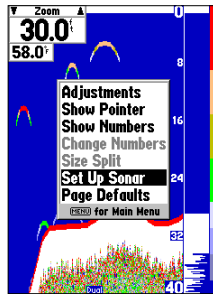

Sonar Page Menu Options

To display the Sonar Page options:

Press **MENU**.

To select a menu option:

Use the **ROCKER** to highlight the option, and press **ENTER**.

The following options are available:

Adjustments—lists the Adjustment Menu options and their current settings (see page 79).

To change an Adjustment setting:

1. While on the **Adjustment options** list, use the **ROCKER** to highlight the option, and press **ENTER**.
2. Use the **ROCKER** to make the change, and press **ENTER**.

Show/Hide Pointer—allows you to reference sonar items and mark underwater waypoints. This makes it easier to find and use an object such as a stump for a future fishing location. When using this feature, the Sonar Page pauses. The pointer does not move off the paused display and cannot show an area that has scrolled off the screen. The depth is updated while the display is paused, but the unit does not show any new sonar data until the standard Sonar Page is resumed. You can see a discontinuity from where the sonar information stops to where it starts again.

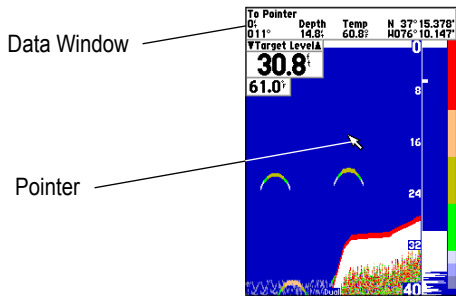

Show Pointer Option

To mark an underwater waypoint:

1. From the Sonar Page, press **MENU**, highlight **Show Pointer**, and press **ENTER** to pause the screen movement.
2. Use the **ROCKER** to move the pointer onto the target, such as underwater drop offs and stumps, you want to mark. The data window at the top of the screen displays the pointer's depth, coordinates, bearing, and distance from your current position.
3. Press **ENTER/MARK**. The New Waypoint Page appears with the waypoint's coordinates, default three-digit name, and pointer depth automatically filled in.

4. To change the name, symbol or depth, highlight the appropriate field, and press **ENTER**. Make your changes and press **ENTER** when finished.
5. When finished, highlight **OK**, and press **ENTER**.
6. To return to the standard Sonar Page, press **QUIT**, or press **MENU**, highlight **Hide Pointer**, and press **ENTER**.

Show/Hide Numbers—toggles showing/hiding the data fields on the sonar display.

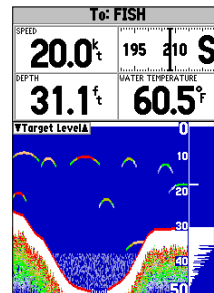

Show Numbers Option

Change Numbers—allows you to specify the type of data displayed in each data field. For detailed instructions on changing the data fields, see page 31.

Size Split—enables width adjustment of the Sonar Page split screen. This option is available only when a split screen zoom scale is selected. Adjust the size of the split window anywhere from 1/4 to 3/4 width of the right half of the Sonar Page.

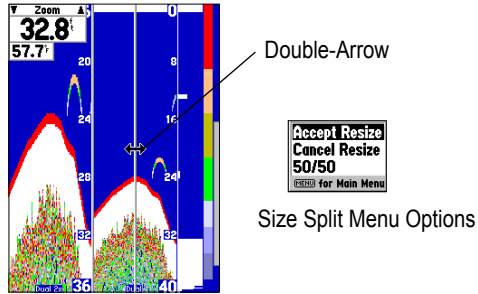

Resizing the Split Sonar Display

Sonar Tab Options

To access and change a setting on the Sonar tab:

1. Press **MENU** twice to access the Main Menu. Use the **ROCKER** to highlight the Sonar tab.
2. Using the **ROCKER**, highlight the field, and press **ENTER**.
3. Highlight the setting, and press **ENTER**.
4. Press **QUIT** to return to the Sonar Page or previous page.

Fish Symbols—determines how the Sonar Page displays underwater targets and background information. If you select off, the unit does not show fish symbols. If you select fish symbols, the Sonar Page shows only the information related to that symbol. Actual fish returns do not always appear as perfect arches (like in Simulator Mode), due to the speed, fish orientation, or other conditions.

Off

Fish Symbols Off.



Suspended targets displays as fish symbols. Background information is displayed.



Same as above with the target depth attached.



Suspended targets display as fish symbols. No background information is displayed.



Same as above with target depth attached.

Water Type—because sound waves travel through Fresh and Salt water at different rates it is necessary to select the Water Type to ensure accurate readings on the unit.

Depth Number—controls the efficiency of the digital depth update rate. Fast Update updates more quickly and is recommended for low-noise, deeper water (>50 ft). Auto is best for shallow water or high noise areas, and produces a slower screen update. Use Auto when you travel a wide variety of depths.



***NOTE:** If the unit is unable to track the bottom for any reason, the digits in the depth window flash on and off to alert you that the unit is not tracking the bottom.*

GPS	Fish Symbols	Water Type
Tide	Off	Salt
Trip		
Celex	Depth Number	Scale
Points	Fast Update	Overlay
Route	Color Bar	Flasher
Track	Off	Off
DSC		
Card	Keel Offset	
Time	0.0'	
Pages		
Map	Map Split Sonar Detail	
View	Maximum Detail	
Temp	Temperature Graph	
Cont	Off	
System		
Units	Background Color	
Comm	Black	
Alarm		
	Calibrate Water Speed	

Main Menu—Sonar Tab

Scale—controls the depth Scale displayed vertically along the right side of the graph. The depth Scale can be configured to display four different ways: as an Overlay, in the Corners, with Basic, or No Scale.

Color Bar—shows a gradient scale of the current Target Level setting (see page 81).

Depth Scale (Overlay)

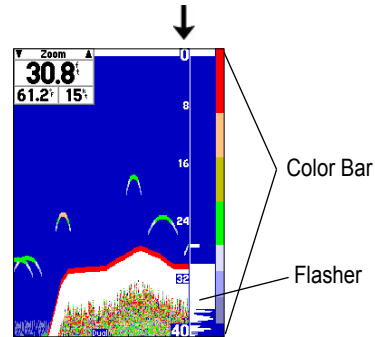

Flasher—with the Flasher active, a graphic Flasher representation is displayed on the far right side of the graph. This graphic Flasher displays structure and bottom returns much the same as a true Flasher. This feature is particularly useful when using fish symbols.

Keel Offset—controls offset the surface reading for the depth of a keel. This makes it possible to measure depth from the bottom of your keel instead of from the transducer’s location. Enter a positive number to offset for a keel, or enter a negative number to compensate for a large vessel that can draw several feet of water. The Keel Offset reflects in the depth reading.

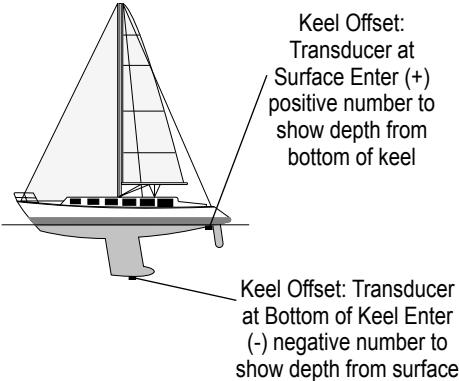

Map Split Sonar Detail—controls Map Page sonar split range scale. Full Range shows the entire scale of 2X or 4X left side split of Sonar Page. Maximum Detail displays what is shown on the left side of a split sonar screen.

Background Color—sets the background color on the Sonar Page to Black, Blue, or White.

Calibrate Water Speed—is only available if you are using a speed-capable transducer/sensor. Calibration is required to ensure the Water Speed displayed on your unit is accurate. The unit automatically use the GPS ground speed, if it is available, for comparison on the calibration. If a GPS ground speed is not available, use either your boat’s speedometer reading (not always accurate) or a stopwatch to determine your speed over a certain distance (distance / time = speed). It is recommended that the calibration take place in water having little or no current.

Calibrating the
Speed Sensor

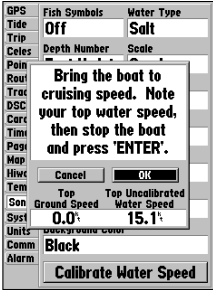

To calibrate the water speed:

1. On the **Sonar** tab, use the **ROCKER** to highlight **Calibrate Water Speed**, and press **ENTER**.
2. Bring the boat to a cruising speed. The top ground and uncalibrated water speeds are shown at the bottom of the calibration window. Note your top water speed, stop the boat, and press **ENTER**.
3. By default, the top ground speed automatically displays in the What was your top water speed? field. If a ground speed is not available, the top uncalibrated water speed is used instead. If the new speed is correct, highlight **OK**, and press **ENTER**. If you want to manually enter a calibration, press **ENTER** on the speed field, enter a new speed, and then press **ENTER**.
4. You can also press **MENU** on the calibration screen and choose **Use Top Ground Speed** to default back to ground speed or **Use No Calibration** to use the speed sensor's uncalibrated speed.



***NOTE:** If the boat is not moving fast enough or the speed sensor is not outputting a speed, the message “Boat Is Not Moving Fast Enough To Calibrate” appears at the bottom of the screen. Either verify the speed sensor wheel is moving, or safely increase boat speed. If there is a problem with the speed sensor/unit, or if a speed sensor is not installed, a “Water Speed Sensor Is Not Working” message appears at the bottom of the screen. Check connections of speed sensor cables.*

Page Defaults—restores the Sonar Page settings to the original factory setup.

To restore default settings to the Sonar Tab:

1. Press **MENU**.
2. Highlight **Page Defaults**, and press **ENTER**.

To restore default settings to the Sonar Tab:

Press **MENU**. With **Page Defaults** highlighted, press **ENTER**.

Understanding Sonar

The transducer mounted on your vessel transmits sound waves toward the bottom of a lake, stream, or seabed in a cone-shaped pattern. When a transmitted sound wave strikes an underwater object—such as the bottom, a piece of structure, or a fish—sound is reflected back to the transducer. The transducer collects the reflected sound waves and sends the data to the GPSMAP 182/182C to be processed and displayed. The underwater data is shown on the Sonar display in the order that it is returned: first returned is the first on the display.

Generally speaking, if the only thing between the transducer and the bottom is water, the first strong return comes from the bottom directly below the transducer and sets the bottom level. Weaker secondary returns provide the detailed data. Stronger returns display in darker colors, with red being the strongest return.

Understanding the Sonar Display

One of the first things to understand about sonar is that the transducer sends a beam down to the bottom of the water, much like the beam of a flashlight. The beam starts small near your vessel and expands as it gets to the bottom. Refer to “Transducer Coverage” for more detailed information.

The Sonar Page does not display a three-dimensional representation of the underwater environment; the display is in two-dimensions, much like if you took a picture of an aquarium. Only the depth of the item in the water is displayed. The Sonar display does not show you where an item is located horizontally in the water, as shown in the drawings below. The fish is not directly above the tree in reality, but it can look like they are on the Sonar Page.

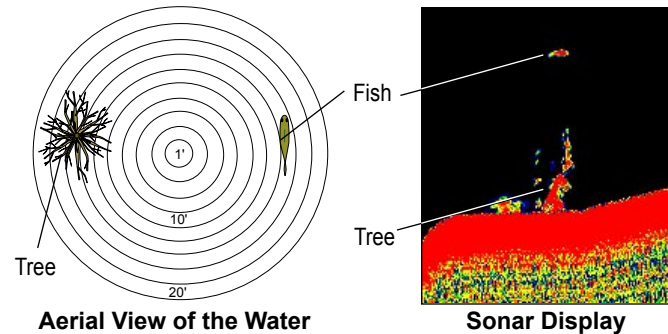

Transducer Coverage

The area covered by the transmitted sound waves is determined by the cone angle of the transducer and the water depth. The wide cone angles (40°) associated with low frequencies (50 kHz) provide a large coverage area for finding fish within a coverage width that is approximately $2/3$ of the water depth. However, this also means that wide cone angles produce less bottom detail and resolution. As shown in the drawing on the near right, the 40° cone angle produces a coverage area of approximately a 20-foot diameter circle at a 30-foot depth.

The narrow cone angles (10°) associated with the high frequencies (200 kHz) provide better bottom resolution and crisper detail, but cannot show a large coverage area for finding fish. The 10° cone angle provides a coverage width that is approximately $2/10$ of the water depth. As shown in the drawing on the far right, the 10° cone angle produces a coverage area of approximately a 6-foot diameter circle at a 30-foot depth.

Dual frequency mode combines both frequencies to get the best coverage area and contour/depth readings.

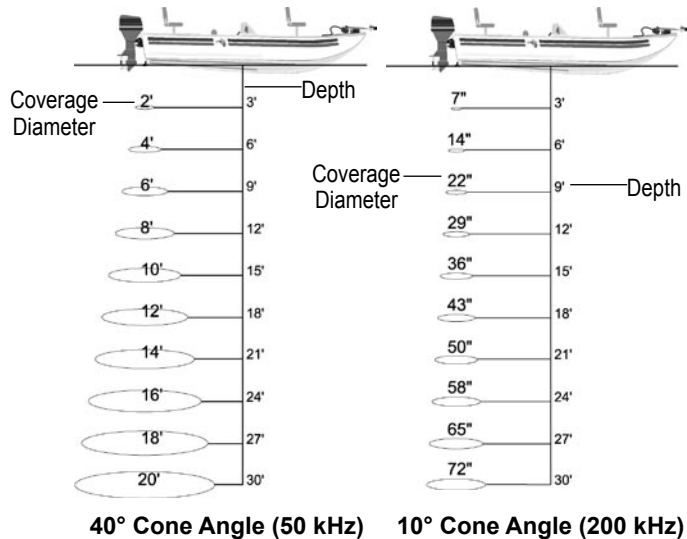

Whiteline

The Sounder Module can help you determine whether the bottom is hard or soft. When the sonar sound waves are reflected back by the bottom, a hard bottom returns a stronger signal than a soft bottom. A thin whiteline indicates a softer bottom, while a thick whiteline indicates a harder bottom. Normally, a red line is used to show the point where water meets the bottom. This line follows the bottom contour, along with any significant objects lying on the bottom. The unit uses the whiteline function to make the bottom layer information easier to distinguish.

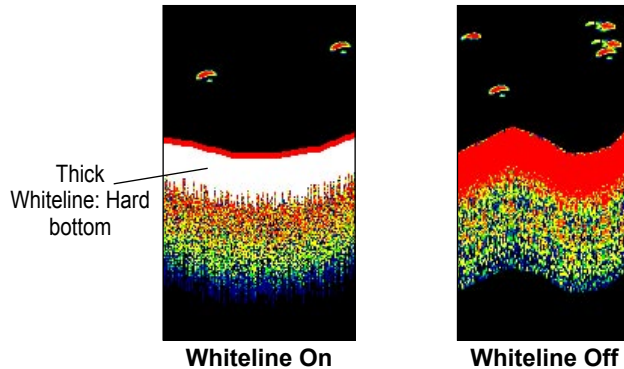

Thermoclines

A rough definition of a thermocline is a break in water where the water temperature changes faster than the water above it. Thermoclines are shown as the weakest colors.

One of the unique features offered by Garmin is See-Thru[®] technology, which allows the GPSMAP 182/182C to hear both weak and strong signals simultaneously so as to identify fish returns under the toughest conditions, such as suspended in thermoclines or even hiding near structures. See-Thru technology allows the Sounder Module to see through thermoclines and locate fish.

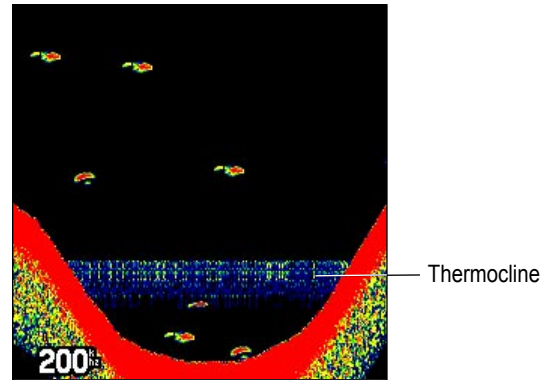

APPENDIX

Specifications

Physical Specifications

Size: 182: 6.18" H x 6.30" W x 2.64" D (15.7cm x 16.0cm x 6.7cm)
 182C: 6.18" H x 6.30" W x 2.64" D (15.7cm x 16.0cm x 6.7cm)

Weight: Less than 2.0 lb (0.763Kg)

Display: 182: 5.5" diagonal (14.1cm)
 182C: 5.0" diagonal (12.7cm) 16-color TFT display with
 backlighting (234 x 320 pixels)

Case: Fully gasketed, high-impact plastic alloy, waterproof to IEC
 529-IPX-7

Temp. Range: 5°F to 158°F (-15°C to 70°C)

Performance

Receiver: Differential-ready 12 parallel channel WAAS capable
 receiver

Acquisition Times:

Warm: Approx. 15 seconds

Cold: Approx. 45 seconds

AutoLocate: Approx. 2 minutes

Update Rate: 1/second, continuous

GPS Accuracy:

Position: <15 meters (49 feet), 95% typical*

Velocity: 0.05 meters/sec steady state

DGPS (USCG) Accuracy:

Position: 3-5 meters (10-16 feet) with optional Garmin
 DGPS receiver, 95% typical*

Velocity: 0.05 meters/sec steady state

DGPS (WAAS) Accuracy:

Position: <3 meters (10 feet), 95% typical*

Velocity: 0.05 meters/sec steady state

Dynamics: 6g's

* Subject to accuracy degradation to 100 m 2DRMS under the U.S. DOD-
 imposed Selective Availability Program.

Power

Source: 182: 8-35 V DC
 182C: 10-35V DC

Usage: 182: 4 watts max. at 13.8 vDC
 182C: 10 watts max. at 13.8vDC

Fuse: AGC/3 AG-2.0 Amp

Installing the GPSPMAP 182/182C

The GPSPMAP 182/182C must be properly installed according to the following instructions to get the best possible performance. If you have the GPSPMAP 182/182C with the built-in internal bail mount antenna, you can skip this section and proceed to the next page. For units purchased with the remote antenna, follow the instructions below. To complete the installation, you need the appropriate fasteners and a 1" x 14-thread marine antenna mount available at most marine dealers.

Mounting the GPS Antenna

The antenna should be mounted in a location that has a clear, unobstructed view of the sky in all directions to ensure the best reception. Avoid mounting the antenna where it is shaded by the boat's superstructure, a radome antenna, or mast. Sailboat users should avoid mounting the antenna high on the mast to prevent inaccurate speed readings caused by excessive heeling. Most marine VHF and LORAN antennas should not seriously degrade the GPS antenna's reception. Never paint the antenna or clean it with harsh solvents.

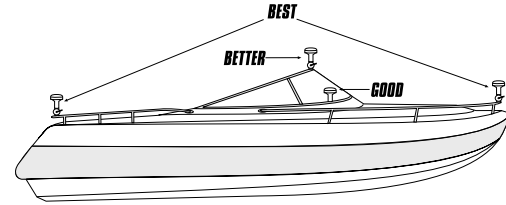

Suggested locations for mounting the external antenna.

The Garmin antenna screws directly onto any standard 1" x 14-thread antenna mount. If you need to raise the antenna to avoid shading, try using a 1" x 14-thread extension mast available at most marine dealers.



NOTE: It is possible to route the coaxial cable either through, or outside the antenna mount. It is possible to remove the BNC connector on the coaxial cable and the coaxial cable shortened to ease installation, however, doing so voids the antenna warranty. If the BNC connector is removed, it must be replaced with a new solder-on or crimp BNC connector.



To install the GPS antenna:

1. Screw the antenna directly onto the 1" x 14-thread mount.
2. Route the cable to the mounting location of the display unit. Use the appropriate tie-wraps, fasteners, and sealant to secure the cable along the route and through any bulkhead or deck.
3. After the GPSMAP 182/182C unit is installed, connect the cable to the antenna connector on the back of the display unit. Make sure that you turn the antenna cable connector 1/4 turn clockwise to lock the cable into place.

Mounting the GPSMAP 182/182C

The GPSMAP 182/182C's compact, waterproof case is suitable for mounting in exposed locations or at the nav station. The unit comes with a gimbal bracket that can be used for surface or overhead mounting. When choosing a location for the display unit, consider the following conditions:

- There should be at least a 3" (7 cm) clearance behind the case to allow connection of the antenna (external antenna only), power/data cables.
- The mounting surface should be heavy enough to support the unit and protect it from excessive vibration and shock.
- For GPSMAP 182/182C units with the built-in internal bail mount antenna, it should be mounted in a location that has the clearest, most unobstructed view of the sky in all directions to ensure the best reception. Avoid mounting the unit where it is blocked by the boat's superstructure, a radar arch, or mast.



NOTE: *The temperature range for the GPSMAP 182/182C is 5°F to 158°F (-15°C to 70°C). Extended exposure to temperatures exceeding this range (in storage or operating conditions) can cause failure of the display. This type of failure and related consequences are NOT covered by the manufacturer's limited warranty.*

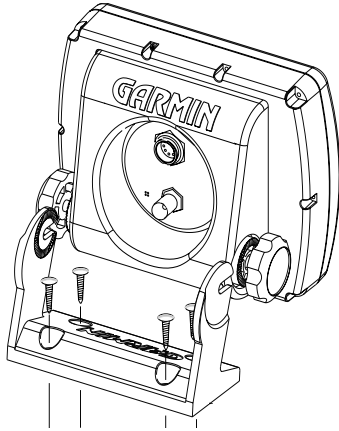

To install the GPSMAP 182/182C unit:

1. Select the location of the mounting bracket.
2. Mark and drill the four mounting holes for the fastener you are using.
3. Fasten the bracket to the surface using the appropriate fastener.
4. Insert the GPSMAP 182/182C into the mounting bracket. The bracket is designed for a tight fit to provide additional support when swiveling the unit.
5. Screw the two mounting knobs through the bracket and into the display case.
6. Connect the power/data and antenna cables (external antenna only) to the back of the unit, making sure the locking rings are fully tightened on both connectors.

The GPSMAP 182/182C with external antenna can be flush mounted on a flat panel of .08-.52" thickness using the cam lobe feature on its gimbal mounting bracket. When flush mounting the GPSMAP 182/182C, be sure to choose an appropriately sized location for the unit (see unit dimensions on page 93) and leave 1.25" (32 mm) clearance below the data card slot for inserting or removing data cards.

To flush mount the GPSMAP 182/182C unit using the gimbal mounting bracket:

1. Cut a 4.33" x 4.33" (110 x 110 mm) hole in the panel.
2. Place the GPSMAP 182/182C into the hole from the front until the flange rests against the mounting surface.
3. From the back of the panel, loosely attach the bracket so the slot in the ratchet area points away from the mounting panel (figure 1).
4. Rotate the bracket downward until the panel is pinched tightly between the unit's flange and bracket lobe (figure 1).
5. Tighten the knobs and connect the power/data and antenna cables.



***NOTE:** if the panel is too thick to allow use of the supplied knobs, use two M6 screws to secure the bracket.*

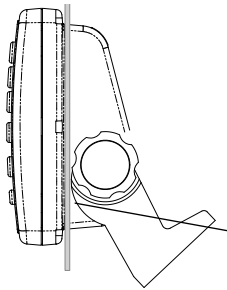

Figure 1
Pull gimbal bracket down until cam lobe contacts surface.

The GPSMAP 182/182C, with external antenna, can be flush mounted on a flat panel using its existing mounting bracket.

To flush mount the GPSMAP 182/182C:

1. Remove the four M5 screws from the back of the unit and remove the mounting bracket.
2. Using the mounting bracket as a template, outline the center relief area and mark the location of the four screw holes centers on your bulkhead or other surface (figure 2).
3. Cut the relief hole from the panel and drill the four 0.20" (5.08 mm) screw holes.
4. Place the GPSMAP 182/182C into the relief hole until it rests flush against the mounting surface.
5. Secure the unit to the mounting surface using the M5 screws. Do not try to force the screws deeper into the holes than the holes allow. For thick mounting surfaces, insert the M5 screws directly thru the drilled holes (figure 3). For thin panels, place the mounting bracket on the back side of the panel for more support. Connect the power/data and antenna cables.

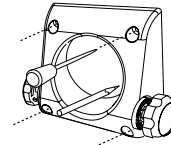

Figure 2

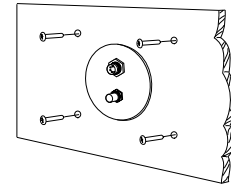

Figure 3

Installing the Ferrite Bead Clamp

In order to filter Radio Frequency Interference (RFI) radiation that could possibly interfere with items such as televisions, radios, or other marine electronics operating in close proximity to the GPSMAP 182/182C with the remote antenna, a ferrite bead filter clamp and neoprene foam strip are included for attachment to the unit's antenna cable. The clamp attaches to the antenna cable near the point it connects to the back of the GPSMAP 182/182C. The foam strip has adhesive on one side and is used to keep the clamp stationary on the cable.

To install the ferrite bead clamp:

1. Choose a location where there is no more than two inches (5 cm) from the back of the GPSMAP 182/182C.
2. Remove the backing from the adhesive foam strip. Place the strip at an angle to the cable with adhesive facing towards the cable. Snugly spiral wrap the foam strip around the antenna cable. (Figure 1)
3. Open the filter clamp by slightly pulling on the latch and opening the filter halves.
4. Position the clamp (Figure 2) and squeeze it shut around the cable until the latch is securely fastened. If the clamp is difficult to close, you can want to remove some of the foam strip.

The clamp should not need to be replaced under normal use. Contact your Garmin dealer or Garmin Product Support if you have any questions or require a replacement filter clamp.

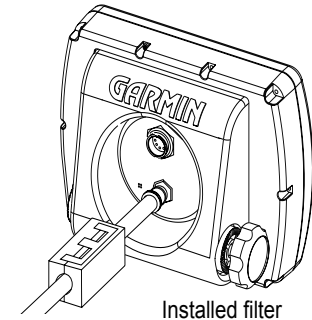
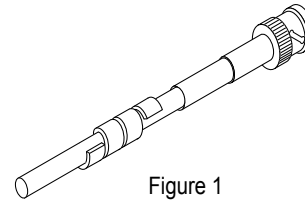
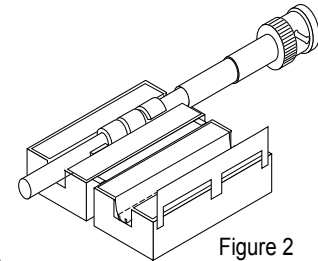
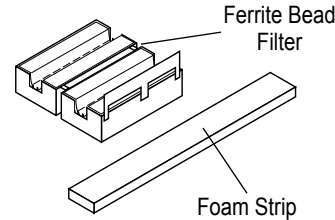

Connecting the Power/Data Cable

The power/data cable connects the GPSMAP 182/182C to a DC system and provides interface capabilities for connecting external devices. The color code in the diagram below indicates the appropriate harness connections. Replacement fuse is a AGC/3AG - 2.0 Amp fuse. For wiring the GPSMAP 182/182C to a GSD 20 Sonar Module, refer to the *GSD 20 Installation Guide*.

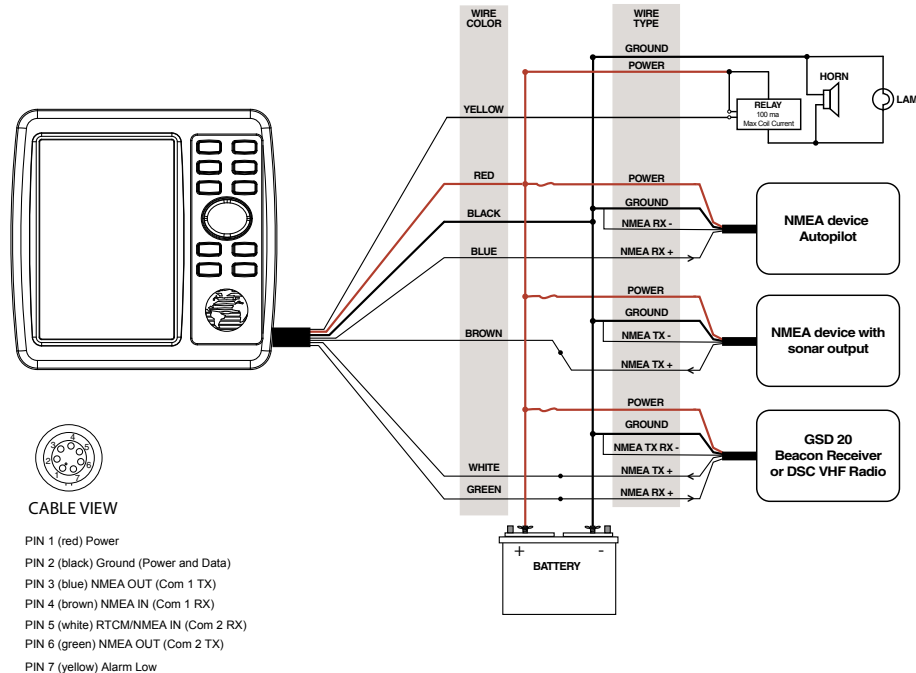

Interfacing

The following formats are supported for connection of external devices:

Garmin proprietary Differential GPS (DGPS), NMEA 0183 versions 3.0, ASCII Text Output, RTCM SC-104 input (vs. 2.0).

The following are the sentences for NMEA 0183, vs. 3.0 output:

Approved sentences—GPRMC, GPGGA, GPGSA, GPGSV, GPGLL, GPBOD, GPRTE, and GPWPL.

Proprietary sentences—PGRME, PGRMZ, and PSLIB. The GPSMAP 182/182C accepts NMEA input with support for the DBT, DPT, DSC, MTW, and VHW sentences.

The GPSMAP 182/182C also includes NMEA input with support for the WPL sentence and sonar NMEA input with support for the DPT (Depth), MTW (Water Temp) and VHW (Water Speed & Heading) sentences. If connecting to COM 2 for sonar NMEA input, the unit interface must be set to NMEA In/NMEA Out. If connecting to COM 1, the unit must be set to NMEA In/NMEA Out.

You can download a copy of Garmin's proprietary communication protocol on the Help and Support section of our Web site at www.garmin.com.

Complete information regarding NMEA and RTCM formats is available for purchase at www.nmea.org

Installing and Removing Data Cards

The GPSMAP 182/182C uses optional Garmin marine BlueChart and MapSource data cards to display digital charts and maps on-screen. Data cards are installed in the card slot located at the bottom right of the unit. Data cards can be installed or removed at any time, whether the unit is on or off.

To install a data card:

1. Open the card door by pressing together on the two handles at the bottom of the door and lifting it up and open.
2. Insert the card, with the label facing front and the handle bottom, into the slot.
3. Firmly push the card into the unit. It is not necessary to force the card and about 1/2" is still exposed when it is properly inserted. If the unit is on, a confirmation tone sounds and a message displays on-screen noting the card details when the card is properly installed and accepted.
4. Close the cover.

If you insert a data card and get a “card format not recognized” message, try removing the card and reinserting it. If the card is still not recognized, contact Garmin Product Support or your Garmin dealer for assistance. Data cards are not waterproof and should not be exposed to moisture or excessive static charges. Data cards should be stored in the case supplied with the card.

To remove a data card:

1. Open the card door by pressing together on the two handles at the bottom of the door and lifting it up and open.
2. Grasp the card handle at the bottom and pull down firmly.
3. If the unit is on, a confirmation tone sounds when the data card has been removed.

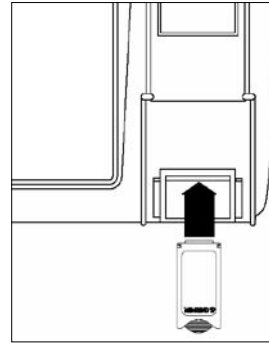

The first time you insert a data card, the unit takes a few seconds to read the card.

After the data card is read, a summary screen appears. Press **ENTER** to acknowledge.

Satellite Information

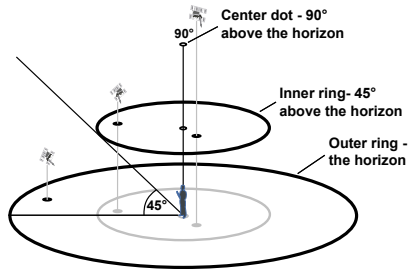

Satellite Sky View

Satellite Location

The location of each available satellite is displayed over two location rings on the Satellite Information Page. The outer ring represents the horizon, the inner ring represents 45° above the horizon, and the center represents directly overhead. When the unit is using a satellite for navigation, the satellite number is highlighted on the location rings. The unit can be set to display satellite location with North or your current track at the top of the display.

Satellite Strength Indicator Bars

The Satellite Strength Indicator Bars show the strength of the signal being received, and the status of the signal. The bars are either shaded or filled. The gray bar means the GPS is in the process of storing orbital data it is receiving from the satellite signal. When the bar turns solid, the GPS is using the satellite signal for navigation. A “D” in or above the bar means that differential corrections (WAAS or DGPS) are being applied to that satellite.

Date, Time, and Current Location

The GPS gets date and time information from the satellite’s on-board atomic clock. When the GPS receiver has achieved a 2D or 3D GPS location, the current location is displayed in the selected location format.

What is WAAS?

The Wide Area Augmentation System (WAAS) is an F.A.A. funded project to improve the overall integrity of the GPS signal. It is a space-based system that broadcasts integrity information and correction data as determined by ground reference stations. WAAS testing completed in September of 2003 confirmed an accuracy of 2 to 3 vertical meters throughout the majority of the continental U.S. and portions of Alaska. For more information, go to <http://gps.faa.gov/Programs/WAAS/waas.htm>.



NOTE: *If you are using the GPSMAP 182/182C outside of the U.S.A., we recommend you turn off WAAS for the most accurate location fix.*

What is Differential GPS (DGPS)?

The U.S. and Canadian governments (among others) have set up Differential GPS (DGPS) stations to transmit correction signals. They are operational in coastal areas and on many navigable river systems. The DGPS system is available for use without a fee.

Refer to the U.S. Coast Guard's Web site, <http://www.uscg.gov/> for locations and the status of the differential sites. Using DGPS requires additional equipment.

What is a Maritime Mobile Service Identity (MMSI)?

Maritime Mobile Service Identity (MMSI) basically allows a VHF radio to act like a phone. In order to make a “call” on a phone, you first need a phone number to dial. The 9 digit MMSI number acts like a phone number when used in a Position Report and as a unique identifier to the Coast Guard when used in an emergency Distress Call. In order to obtain a Maritime Mobile Service Identity (MMSI) number, users must register their VHF radio with the FCC (Form 605). Garmin does not supply this number!

How are MMSI Assignments Obtained?

Non-commercial users (for example, recreational users who remain in domestic waters and only carry VHF, EPIRB (Emergency Position Indicating Radio Beacons), and Radar) are not required to have a FCC ship station license. The FCC and Coast Guard have authorized some second and third party vendors to assign MMSI numbers. This service is limited to registering recreational vessels only. To receive information on how to obtain a recreational MMSI number contact: <http://www.uscg.mil/rescue21/links/mmsi.htm> or <http://wireless.fcc.gov/marine/>.

U.S. Non-Federal User: Commercial users, or those who travel outside the U.S. or Canada, must apply for a ship station license, or an amendment to a ship station license. To find out if you require a Ship Station license contact: <http://wireless.fcc.gov/marine/fctsht14.html>. If your vessel requires licensing by the FCC you obtain a MMSI during the application/licensing process when you file FCC Forms 159 and 605.

U.S. Federal User: Federal users can obtain MMSI assignments from their agency radio spectrum management office. These procedures are currently under review by the NTIA (National Telecommunications and Information Administration).

Outside the U.S.: Users can obtain an MMSI assignment from their telecommunications authority or ship registry, often by obtaining or amending their ship station license.

In Canada: Industry Canada is responsible for assigning MMSI numbers to commercial and recreational vessels. Information is available at the following web site: <http://apollo.ic.gc.ca/english/mmsi.html>.

For information regarding MMSI's visit: <http://www.navcen.uscg.gov/marcomms/gmdss/mmsi.htm>.

Navigation Terms

Avg Speed—the average of all second-by-second speed readings since last reset.

Bearing (BRG)—the compass direction from your current location to a destination.

Course—the course between the active from and to waypoints.

Depth—the depth below transducer. This field is active only if a transducer is connected to the GPSMAP 182/182C.

Distance (Dist)—the distance from the current location to a destination.

Dist to Destination—the distance from the current location to a Go To destination, or the final waypoint in a route.

Dist to Next—the distance from current location to a Go To destination, or the next waypoint in a route.

DOP (Dilution of Precision)—reflects the quality of the GPS signals and satellite geometry.

Elevation—height above mean sea level (MSL).

ETA (Estimate Time of Arrival)—the time you estimate to reach your destination waypoint, based on current speed and track.

ETA at Destination—the time you estimate to reach a Go To destination or the final waypoint in a route.

ETA at Next—the time you estimate to reach a Go To destination or the next waypoint in a route.

Fuel—the fuel required to travel from current location to the indicated route waypoint.

GPS Accuracy—estimated accuracy of the GPS position.

Leg Dist—the distance between two route waypoints.

Leg Fuel—the fuel required to travel from a route waypoint to the next waypoint (in sequence) in the route.

Leg Time—the time required to travel from a route waypoint to the next waypoint (in sequence) in the route.

Max Speed—the maximum second-by-second speed recorded since last reset.

Moving Average Speed—average speed while the unit is moving.

Moving Trip Timer—total time the unit has been moving.

Odometer—a running tally of distance travelled, based on the distance between second-by-second position readings.

Off Course—the distance you are off course in either direction, left or right.

Pointer—an arrow pointing to your destination.

Speed—the current velocity at which you are travelling, relative to a ground position. Also referred to as ground speed.

Sunrise—the current day's time of sunrise.

Sunset—the current day's time of sunset.

Time Of Day—the current time.

Time To—the estimated time required to reach a Go To destination, or the next waypoint in a route. Also known as “estimated time en route.”

Time to Dest—the estimated time required to reach a Go To destination, or the final waypoint in a route.

Time to Next—the estimated time required to reach a Go To destination, or the next waypoint in a route.

To Course—the recommended direction to steer to reduce course error or stay on course. Provides the most efficient heading to get back to the course and proceed along your route.

Track—the direction of movement relative to a ground position. Also referred to as “ground track.”

Trip Odometer—a running tally of distance travelled since last reset. See also “Odometer.”

Total Average Speed—average speed of unit for both moving and stopped speeds since last timer reset.

Total Trip Timer—total time the unit has been in operation since last reset of the trip timers.

Turn—the angle difference between the bearing to your destination and your current track. “L” indicates you should turn left; “R” indicates you should turn right.

VMG (Velocity Made Good)—the speed you are closing in on a destination along a course. Also referred to as the vector velocity to your destination.

Voltage—current voltage reading being received by unit.

Water Speed—the speed through the water. This field is only active if the GPSMAP 182/182C is receiving speed readings from a NMEA device.

Water Temp—the water temperature. This field is only active if the GPSMAP 182/182C is receiving speed readings from a NMEA device.

Waypoint Destination—the final waypoint in the route, or the destination waypoint.

Waypoint Next—the next waypoint in the route.

Messages

Approaching Turn—you are nearing a turn in a route.

Arriving at Destination—you are nearing your destination.

Batteries Low—you have less than 10 minutes of battery left.

Can't Unlock Maps—no applicable unlock code for one or more maps was found.

Cannot display all found, use city or postal code—the unit found too many items to display. Narrow the search using the city or postal code.

Database Error—internal problem with the unit. Contact your dealer or Garmin Product Support to have the unit repaired.

Deep Water—the water is deeper than the amount set in the Deep Water Alarm.

Dragging Anchor—the distance set in the Anchor Alarm is exceeded.

Lost Satellite Reception—the unit is unable to continue receiving satellite signals.

Memory Full—unit memory is full; no further data can be saved.

Near Proximity Point—you are nearing a proximity waypoint.

No Diff GPS Location—RTCM is selected but no DGPS data is being received.

No Tide Stations for that Area—no tide stations within 100 miles of the area.

None Found—no data matched the search criteria.

Off Course—you are off course the distance set in the “Off Course” alarm.

Proximity Memory Full—no additional proximity waypoints can be saved.

Proximity Radius Overlaps—the radii of two proximity waypoints overlap.

Route Already Exists—you have entered a route name that already exists.

Route Memory Full—no additional routes can be saved.

Route Truncated—uploaded route from another device has more than 254 waypoints.

Route Waypoint Memory Full—no additional route waypoints can be saved.

Shallow Water—the water is shallower than the depth set in the Shallow Water Alarm.

Track Already Exists—a saved track with the same name already exists.

Track Memory Full—no more track data can be stored without deleting old data.

Track Log Full—the track log is full and track recording has been turned off. To record more track points, you need to clear the track log and turn track recording on. This is only displayed when the track recording setting is set to “Stop When Full.”

Track Truncated—a complete uploaded track does not fit in memory. The oldest track log points have been deleted.

Transfer Complete—data transfer has been completed.

Waypoint Already Exists—a waypoint with the same name already exists.

Waypoint Memory Full—the unit has stored the maximum number of waypoints.

LORAN TD System

LORAN C is a radio navigation aid operated and maintained in the United States by the United States Coast Guard. The name LORAN is an acronym for “LOng RANge Navigation.” The LORAN system covers the entire United States and the U.S. Coastal Confluence Zone. From the perspective of a mariner, the system is used for ocean and coastal navigation. It can be used as a supplemental system for harbor and harbor approach navigation, and it is used for inland navigation by recreational vehicles.



Change to Loran TD from the Units tab on the Main Menu.

LORAN TD Feature

The LORAN TD (Time Delay) feature eases the transition from using LORAN to using GPS. The GPSMAP unit automatically converts GPS coordinates to LORAN TDs for those who have a collection of LORAN fixes for favorite fishing spots and other waypoints recorded as TDs. You can display your position as a TD or enter waypoints as TDs. The accuracy to be expected from this conversion is approximately 30 meters. When the unit is placed in the LORAN TD format mode, it simulates the operation of a LORAN receiver. Position coordinates can be displayed as TDs, and all navigation functions can be used as if the unit was actually receiving LORAN signals.

Using the LORAN TD Format

When creating new waypoints using LORAN TD coordinates, you must set the correct LORAN chain number and secondary stations in the Setup TD field before storing the waypoint. After the waypoint is stored in unit memory, it always references the LORAN chain number and secondary stations currently selected in the Setup TD field. If you enter a different LORAN chain number or change the secondary stations or offsets in the Setup TD field, the active waypoint information reflects those changes. Because the GPSMAP 182/182C does not rely on the LORAN signal for navigation, it can reference a different GRI chain and/or secondary stations and still navigate to the location stored in memory.

The LORAN Position Format field is located on the Setup–Location tab on the Main Menu. The LORAN TD Setup window contains the fields to select the Loran GRI-Chain Number, Primary and Secondary Stations, and TD Offsets.

To set up Loran TD from the Main Menu:

1. Press **MENU** twice to display the Main Menu.
2. Using the **ROCKER**, highlight the **Position Format** field on the **Units** tab, and press **ENTER**.
3. Highlight **Loran TD** and press **ENTER**.
4. Highlight **Setup** and press **ENTER**.
5. To change the settings of any of the five fields, highlight the field, press **ENTER**, select/enter the setting, and press **ENTER**.
6. When finished, highlight **Save**, and press **ENTER**.

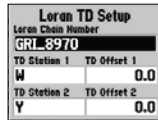

Loran TD Setup Page

If the active GRI Chain, secondary stations, or offsets were changed since the waypoint was created, the waypoint now references the active GRI-chain and secondary stations. You must adjust the TD coordinates accordingly. Remember that the GPS is not relying on the LORAN signal for navigation and actually converts the TD coordinate to a useful LAT/LON coordinate before storing the waypoint to memory or using it for navigation. Because of this, the unit can navigate to a TD coordinate anywhere in the world.

You must know your GRI chain number and secondary stations to create a LORAN TD position. For more information, read our LORAN TD Position Format Handbook, available from the Garmin Web site (www.garmin.com/support/userManual.jsp.)

Optional Accessories

The following optional accessories are designed to enhance the operation of the GPSMAP 182/182C.

To obtain replacement parts and optional accessories, contact your Garmin Dealer, Garmin Product Support in the U.S.A. at 800-800-1020, or Garmin Europe at 44-0870-8501241.



WARNING: *Garmin accessories have been designed and specifically tested for use with Garmin products. Accessories offered by other manufacturers have not been tested or approved for use with Garmin products. Use of such accessories could cause damage to the GPSMAP 182/182C and void the warranty.*

MapSource Software CD-ROMs—enhances the basemap, create waypoints and routes from your PC. MapSource offers several detailed mapping options that are compatible with the GPSMAP 182/182C, including MetroGuide, Recreational Lakes with Fishing Hot Spots, and Minnesota LakeMaster ProMap.

Programmable Data Cards—blank data cards are available in 8 MB, 16 MB, 32 MB, 64 MB, 128 MB, and 256 MB sizes. Download street-level map detail, points of interest, business addresses and phone numbers, marine data, topographical information, and more from MapSource CD-ROMs to a data card, either directly through your GPSMAP 182/182C using the PC Interface Cable, or with the Data Card Programmer.

USB Data Card Programmer—programs blank data cards at high speed through a PC.

Pre-Programmed Data Cards—data cards pre-programmed with either Garmin BlueChart or Fishing Hot Spots map data.

A/C Adapter—powers the unit using a standard AC house current.

PC Interface Cable with vehicle Power Adapter—connects the GPSMAP 182/182C to a vehicle's electrical system on one end, and a PC, beacon receiver, marine autopilot, or other compatible device on the other end.

Software License Agreement

BY USING THE GPSMAP 182/182C, YOU AGREE TO BE BOUND BY THE TERMS AND CONDITIONS OF THE FOLLOWING SOFTWARE LICENSE AGREEMENT. PLEASE READ THIS AGREEMENT CAREFULLY.

Garmin grants you a limited license to use the software embedded in this device (the “Software”) in binary executable form in the normal operation of the product. Title, ownership rights, and intellectual property rights in and to the Software remain in Garmin.

You acknowledge that the Software is the property of Garmin and is protected under the United States of America copyright laws and international copyright treaties. You further acknowledge that the structure, organization, and code of the Software are valuable trade secrets of Garmin and that the Software in source code form remains a valuable trade secret of Garmin. You agree not to decompile, disassemble, modify, reverse assemble, reverse engineer, or reduce to human readable form the Software or any part thereof or create any derivative works based on the Software. You agree not to export or re-export the Software to any country in violation of the export control laws of the United States of America.

Product Registration

Help us better support you by completing our online registration today! Have the serial number of your GPSMAP 182/182C handy and connect to our Web site (<http://www.garmin.com>). Look for the Product Registration link on our Home page.

Use this area to record the serial number (8-digit number located on the back of the box) in case your GPSMAP 182/182C unit is lost, stolen, or needs service. Be sure to keep your original sales receipt in a safe place or attach a photocopy inside the manual.

Serial Number: _____

Contact Garmin

If you should encounter any difficulty while using your GPSMAP 182/182C, or if you have any questions, in the U.S.A. contact Garmin Product Support by phone: 913-397-8200 or 800-800-1020, Monday–Friday, 8 AM–5 PM Central Time, or by e-mail at sales@garmin.com.

In Europe, contact Garmin (Europe) Ltd. at 44-0870.8501241.

Limited Warranty

This Garmin product is warranted to be free from defects in materials or workmanship for one year from the date of purchase. Within this period, Garmin will at its sole option repair or replace any components that fail in normal use. Such repairs or replacement will be made at no charge to the customer for parts or labor, provided that the customer shall be responsible for any transportation cost. This warranty does not cover failures due to abuse, misuse, accident or unauthorized alteration or repairs.

THE WARRANTIES AND REMEDIES CONTAINED HEREIN ARE EXCLUSIVE AND IN LIEU OF ALL OTHER WARRANTIES EXPRESS OR IMPLIED OR STATUTORY, INCLUDING ANY LIABILITY ARISING UNDER ANY WARRANTY OF MERCHANTABILITY OR FITNESS FOR A PARTICULAR PURPOSE, STATUTORY OR OTHERWISE. THIS WARRANTY GIVES YOU SPECIFIC LEGAL RIGHTS, WHICH MAY VARY FROM STATE TO STATE.

IN NO EVENT SHALL GARMIN BE LIABLE FOR ANY INCIDENTAL, SPECIAL, INDIRECT OR CONSEQUENTIAL DAMAGES, WHETHER RESULTING FROM THE USE, MISUSE, OR INABILITY TO USE THIS PRODUCT OR FROM DEFECTS IN THE PRODUCT. Some states do not allow the exclusion of incidental or consequential damages, so the above limitations may not apply to you.

Garmin retains the exclusive right to repair or replace the unit or software or offer a full refund of the purchase price at its sole discretion. SUCH REMEDY SHALL BE YOUR SOLE AND EXCLUSIVE REMEDY FOR ANY BREACH OF WARRANTY. To obtain warranty service, contact your local Garmin authorized dealer or call Garmin Product Support for shipping instructions and an RMA tracking number. The unit should be securely

packed with the tracking number clearly written on the outside of the package. The unit should then be sent, freight charges prepaid, to any Garmin warranty service station. A copy of the original sales receipt is required as the proof of purchase for warranty repairs.

Garmin International, Inc.
1200 E 151st Street, Olathe, Kansas 66062 U.S.A.
Tel. 913/397.8200
Fax. 913/397.8282

Garmin (Europe) Ltd.
Unit 5, The Quadrangle, Abbey Park Industrial Estate, Romsey, SO51 9DL
U.K.
Tel. 44/0870.8501241
Fax 44/0870.8501251

Online Auction Purchases: Products sold through online auctions are not eligible for rebates or other special offers from Garmin. Online auction confirmations are not accepted for warranty verification. To obtain warranty service, an original or copy of the sales receipt from the original retailer is required. Garmin will not replace missing components from any package purchased through an online auction.

International Purchases: A separate warranty is provided by international distributors for units purchased outside the United States. This warranty is provided by the local in-country distributor and this distributor provides local service for your unit. Distributor warranties are only valid in the area of intended distribution. Units purchased in the United States or Canada must be returned to the Garmin service center in the United Kingdom, the United States, Canada, or Taiwan for service.

The Garmin GPSMAP 182/182C has no user-serviceable parts. Should you ever encounter a problem with your unit, please take it to an authorized Garmin dealer for repairs.

The GPSMAP 182/182C is fastened shut with screws. Any attempt to open the case to change or modify the unit in any way will void your warranty and may result in permanent damage to the equipment.

FCC Compliance

The GPSMAP 182/182C complies with Part 15 of the FCC interference limits for Class B digital devices FOR HOME OR OFFICE USE. These limits are designed to provide more reasonable protection against harmful interference in a residential installation, and are more stringent than “outdoor” requirements.

Operation of this device is subject to the following conditions: (1) This device may not cause harmful interference, and (2) this device must accept any interference received, including interference that may cause undesired operation.

This equipment generates, uses, and can radiate radio frequency energy and may cause harmful interference to radio communications if not installed and used in accordance with the instructions. However, there is no guarantee that interference will not occur in a particular

installation. If this equipment does cause harmful interference to radio or television reception, which can be determined by turning the equipment off and on, the user is encouraged to try to correct the interference by one of the following measures:

- Reorient or relocate the receiving antenna.
- Increase the separation between the equipment and the receiver.
- Connect the equipment into an outlet on a circuit different from that to which the receiver is connected.
- Consult the dealer or an experienced radio/TV technician for help.

The GPSMAP 182/182C does not contain any user-serviceable parts. Repairs should only be made by an authorized Garmin service center. Unauthorized repairs or modifications could result in permanent damage to the equipment, and void your warranty and your authority to operate this device under Part 15 regulations.

Safety Information

CAUTION: Use the GPSMAP 182/182C at your own risk. To reduce the risk of unsafe operation, carefully review and understand all aspects of this Owner's Manual—and thoroughly practice operation using Simulator Mode prior to actual use. When in actual use, carefully compare indications from the GPSMAP 182/182C to all available navigation sources, including information from other NAVAIDs, visual sightings, charts, etc. For safety, always resolve any discrepancies before continuing navigation.

CAUTION: IT IS THE USER'S RESPONSIBILITY TO USE THIS PRODUCT PRUDENTLY. THIS PRODUCT IS INTENDED TO BE USED ONLY AS A NAVIGATIONAL AID AND MUST NOT BE USED FOR ANY PURPOSE REQUIRING PRECISE MEASUREMENT OF DIRECTION, DISTANCE, LOCATION OR TOPOGRAPHY. THIS PRODUCT SHOULD NOT BE USED TO DETERMINE GROUND PROXIMITY FOR AIRCRAFT NAVIGATION.

CAUTION: The electronic chart is an aid to navigation and is designed to facilitate the use of authorized government charts, not replace them. Only official government charts and notices to mariners contain all information needed for safe navigation—and, as always, the user is responsible for their prudent use.

MAP DATA INFORMATION: One of the goals of Garmin is to provide customers with the most complete and accurate cartography that is available to us at a reasonable cost. We use a combination of governmental and private data sources, which we identify as required in product literature and copyright messages displayed to the consumer. Virtually all data sources contain inaccurate or incomplete data to some degree. This is particularly true outside the United States, where complete and accurate digital data is either not available or prohibitively expensive.

WARNING: The Global Positioning System (GPS) is operated by the United States government, which is solely responsible for its accuracy and maintenance. The system is subject to changes which could affect the accuracy and performance of all GPS equipment. Although the Garmin GPSMAP 182/182C is a precision electronic NAVigation AID (NAVAID), any NAVAID can be misused or misinterpreted, and therefore become unsafe.

WARNING: This product, its packaging, and its components contain chemicals known to the State of California to cause cancer, birth defects, or reproductive harm. This Notice is being provided in accordance with California's Proposition 65. If you have any questions or would like additional information, please refer to our Web site at <http://www.garmin.com/prop65>.

INDEX

Symbols

- 2D Differential 42
- 2D GPS Location 89, 101
- 3D Differential 42
- 3D GPS Location 101

A

- Accessories 110
- Accuracy 40
- Accuracy Alarm 76
- Accuracy Circle 68
- Active Route Page 37
 - Options 38
- Alarms
 - Accuracy 76
 - Anchor Drag 76
 - Arrival 77
 - Battery 76
 - Clock 76
 - DGPS 76
 - DSC 25
 - Fish 77
 - Off Course 77
 - Shallow/Deep Water 77
 - Temperature 77
- Alarm Tab 76

- Anchor Drag Alarm 76
- Arrival Alarm 77

B

- BackLight 4
- Base Map 65
- Battery Alarm 76
- Bearing Line 67
- Bottom Split 81

C

- Card Tab 62
- Celestial Tab 47
- Cleaning iv
- Clock Alarm 76
- Color Mode 65
- Communication Tab 72
- Correction Signals 102
- Course Line 67
- Course Up 64

D

- Data Cards 100
- Data Entry 6
- Data Fields
 - Change Numbers 31
 - Show 31
 - Split Fields 35
- Date/Time 101
- Daylight Saving Time 63
- Delete

- DSC Directory Item 24
- Depth Line 82
- DGPS 102
 - Alarm 76
- Differential GPS 102
- Dilution of Precision 104
- Distance 60
- Distress Calls 22, 22–25
- DOP 104
- DSC 22
 - Call List 24
 - Directory 24
 - Log 24
 - Setting Up 25
- DSC Tab 62

E

- Edit
 - Route 56
 - Waypoint 11
- Enter/Mark Key 5, 8

F

- FCC Compliance 113
- Features 5
- Find 19
 - Additional Information 21
- Find Key 5, 19
- Fish Alarm 77
- Flasher 86

G

- Gain 81
- Garmin Data Transfer 72
- Go To 13
 - Distress Call 25
 - Position Report 25
- GPS Tab 40
 - Options 43
- GSD 20 78

H

- Heading Line 67
- Highway Page 35
 - Options 36
 - Setup 37
- Highway Tab 68

I

- Initializing 1
- Installation 93
- Interface Keys 5
- Interfacing 99
- In Zoom Key 5

K

- Keel Offset 87
- Keypad Usage 5
- Key Beeps 69

L

Language 69
License Agreement 111
LORAN TD 108

M

Magnetic Variation 71
Main Menu 39
Main Pages 26
Man OverBoard 10
MapSource 62
Map Data Information 114
Map Datum 71
Map Detail 64
Map Information Page 65
Map Page 27
 Options 30
 Setup Map 33
Map Pointer 7, 28
Map Scales 29
Map Tab 64
Maritime Mobile Service Identity 103
Mark Key 5
Measure Distance 32
Menu Key 5
Merge From Card 62
Messages 106
MMSI 22, 103
MOB 10
MOB Key 5

N

NAV/MOB Key 5, 12
Nav aids 67
Navigating 12
 Distress Call 25
 Go To 13
 Position Report 25
 Routes 53
 TracBack 14
Navigation Terms 104
Nav Key 5
NMEA 74
Noise Reject 82
North Up 64
Numbers Page 34

O

Off Course Alarm 77
Orientation 64
Out Zoom Key 5
Overzoom 29

P

Pages Tab 63
Page Key 5
Pointer Page 33
 Options 34
Points Tab 49
Position Format 70
Position Reports 23

Power Key 5
Power On/Off 1
Proximity Waypoints 52

Q

Quit Key 5

R

Receiving a DSC Call 25
Replace From Card 62
Review
 DSC Call 23
 Waypoints 11
Rocker Key 5
Routes 17
 Copy 54
 Create 17
 Delete 54
 Delete All 54
 Edit 56
Routes Tab 53
Route Review Page 54
 Options 56
RTCM 75

S

Safety Information 114
Satellite Location 101
Satellite Sky View 101
Selecting Options 6
Shallow/Deep Water Alarm 77

Simulator Mode 3, 114
Sonar 78
 Depth Line 82
 Gain 81
 Noise Reject 82
 Understanding 89
 View/Span 81
 Whiteline 82
Sonar Page 78
 Adjustment Menu 79
 Bottom Split 81
 Options 83
Sonar Tab 69
 Options 85
Specifications 92
Speed Filter 69
Spot Sounding 66
Storage iv
System Information 70
System Tab 69

T

Temperature Scale 68
Temperature Tab 68
Thermoclines 91
Tide Stations 44
Tide Tab 44
Time Format 63
Time Tab 63
Time Zone 63

- TracBack 14
 - Activate 16
 - Track Logs
 - Clear 15
 - Save 15
 - Track Tab 59
 - Active 59
 - Saved 60
 - Track Up 64
 - Transducer 90
 - Trip Planning 58
 - Trip Tab 47
- U**
- Underwater Waypoints 84
 - Units Tab 70
 - Unit Defaults 70
- W**
- WAAS 41, 102
 - Disable/Enable 42
 - Waterproof iv
 - Water Speed 87
 - Water Temperature Alarm 77
 - Waypoints
 - Creating 8
 - Creating Graphically 9
 - Editing 11
 - Enter/Mark 8
 - Move 12
 - Proximity 52
 - Reviewing 11
 - Underwater 84
 - Waypoint Lists
 - Proximity 52
 - User 49
 - Whiteline 82, 91
 - Wide Area Augmentation System 41, 102
 - Wiring Installation 98
- Z**
- Zoom Keys 5
 - Zoom Range 29
 - Zoom Settings 29

**For the latest free software updates (excluding map data) throughout the life of your
Garmin products, visit the Garmin Web site at www.garmin.com.**



© Copyright 2005 Garmin Ltd. or its subsidiaries

Garmin International, Inc.
1200 East 151st Street, Olathe, Kansas 66062, U.S.A.

Garmin (Europe) Ltd.
Unit 5, The Quadrangle, Abbey Park Industrial Estate, Romsey, SO51 9DL, U.K.

Garmin Corporation
No. 68, Jangshu 2nd Road, Shijr, Taipei County, Taiwan

www.garmin.com

Part Number 190-00584-00 Rev. A